

Computer Applications in Biology

New Tools, New Insights, New Science

Robert J. Robbins

Johns Hopkins University

rrobbins@gdb.org

&

Department of Energy

rrobbins@er.doe.gov

Human Genome Project

Overall Goals:

- **construction of a high-resolution genetic map of the human genome;**
- **production of a variety of physical maps of all human chromosomes and of the DNA of selected model organisms;**
- **determination of the complete sequence of human DNA and of the DNA of selected model organisms;**
- **development of capabilities for collecting, storing, distributing, and analyzing the data produced;**
- **creation of appropriate technologies necessary to achieve these objectives.**

USDOE. 1990. Understanding Our Genetic Inheritance. The U.S. Human Genome Project: The First Five Years.

GDB Content

Loci

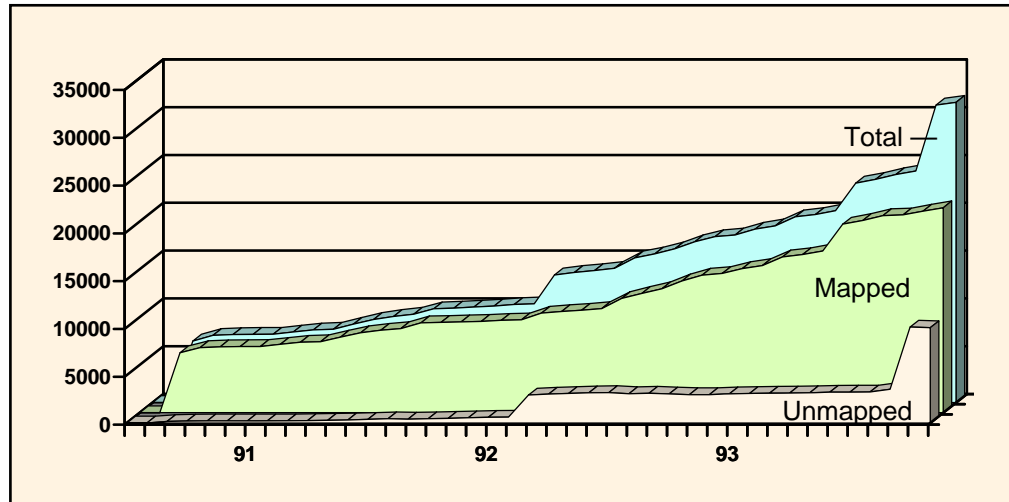

Probes

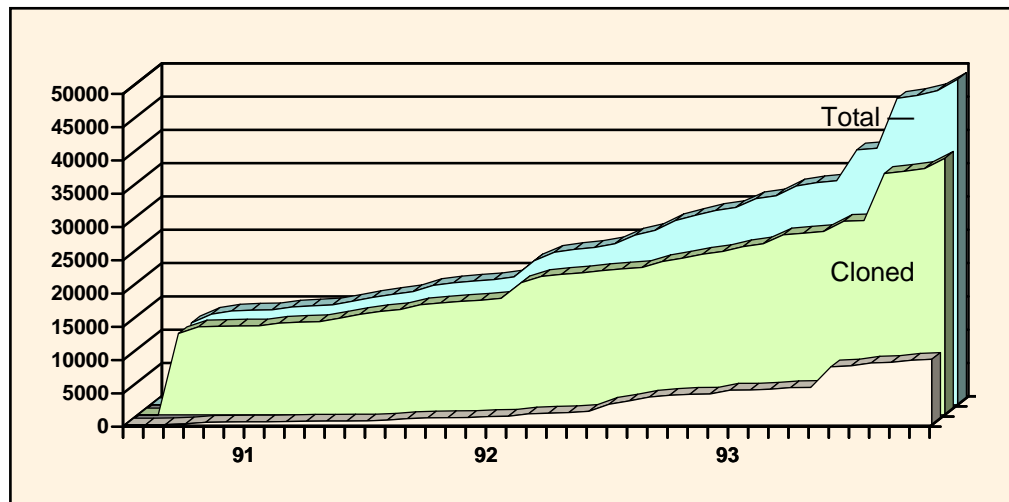

Genes

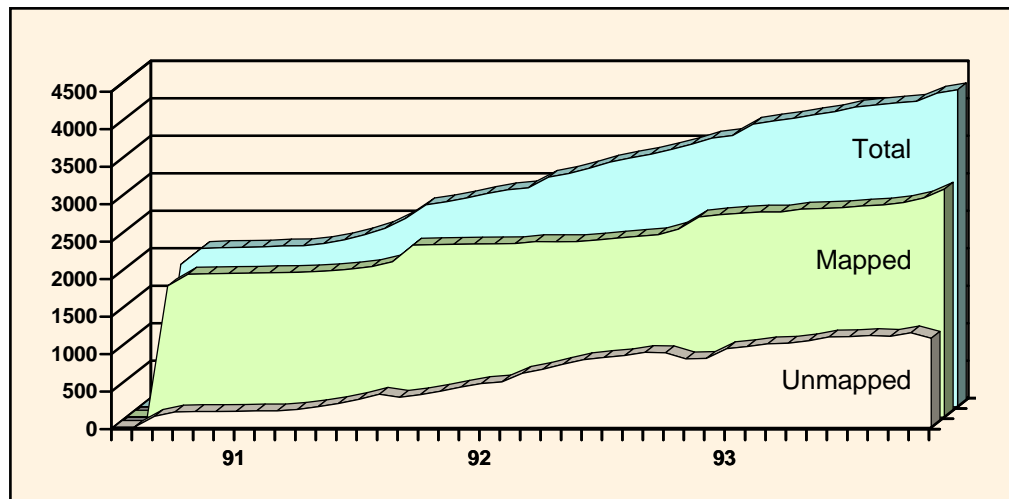

Cumulative Totals GenBank Entries in Base Pairs

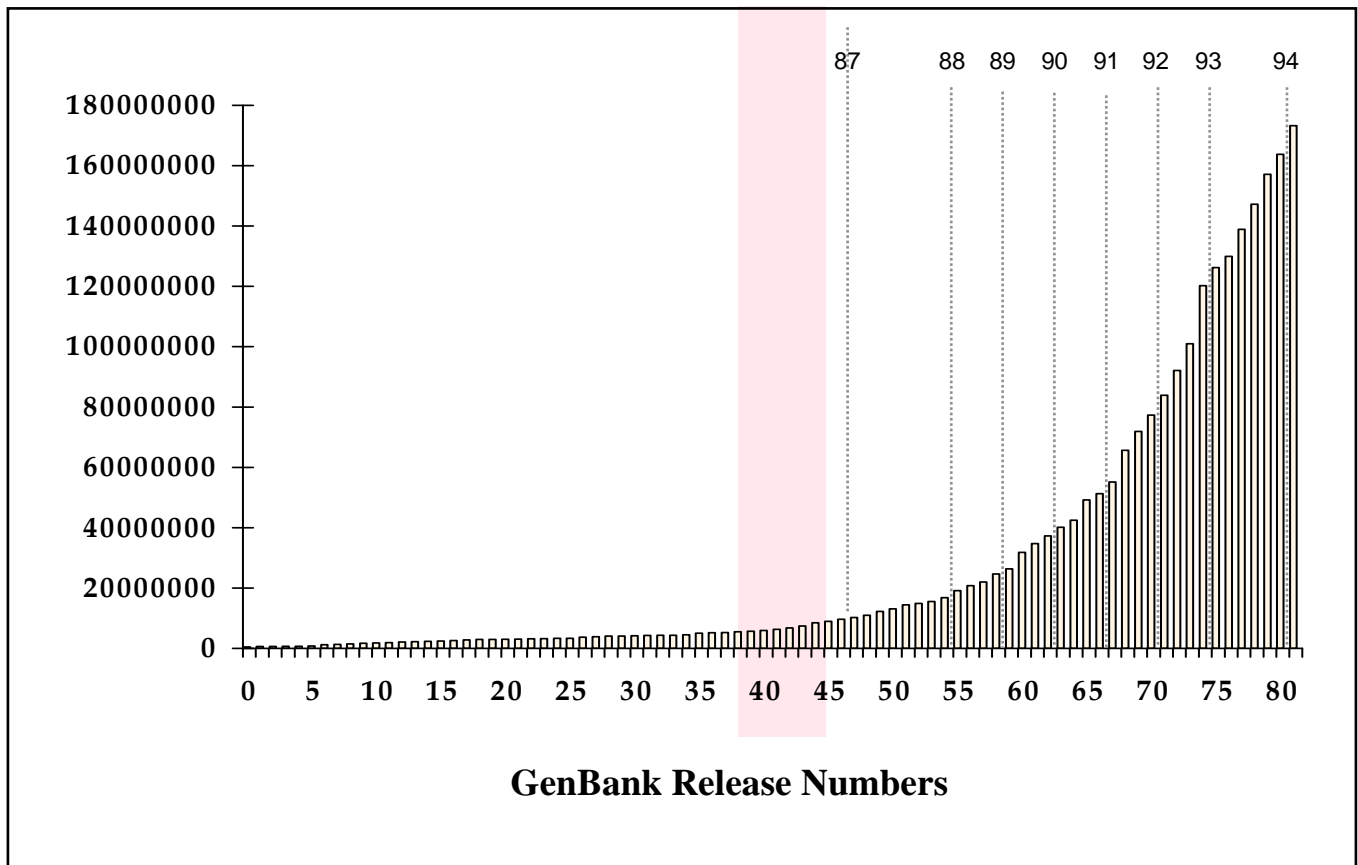

One Human Sequence

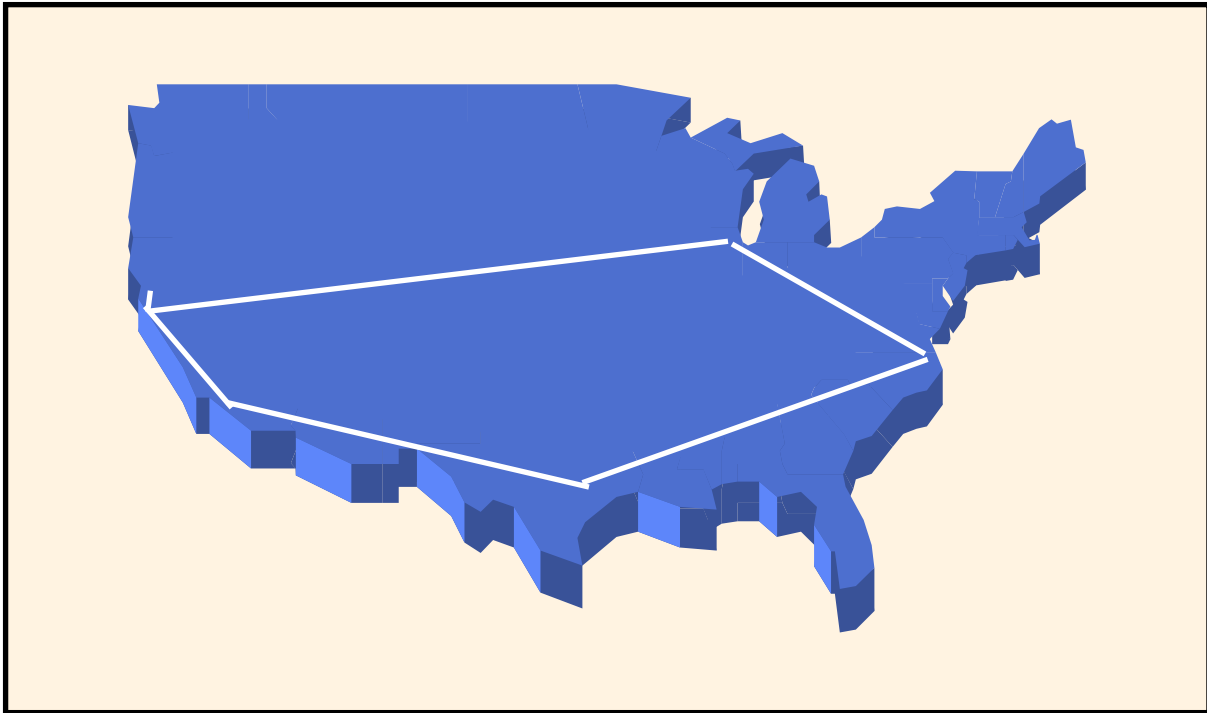

year	per base cost	budget	year	cumulative	percent completed
1995	\$0.50	16,000,000	10,774,411	10,774,411	0.33%
1996	\$0.40	25,000,000	21,043,771	31,818,182	0.96%
1997	\$0.30	35,000,000	39,281,706	71,099,888	2.15%
1998	\$0.20	50,000,000	84,175,084	155,274,972	4.71%
1999	\$0.15	75,000,000	168,350,168	323,625,140	9.81%
2000	\$0.10	100,000,000	336,700,337	660,325,477	20.01%
2001	\$0.05	100,000,000	673,400,673	1,333,726,150	40.42%
2002	\$0.05	100,000,000	673,400,673	2,007,126,824	60.82%
2003	\$0.05	100,000,000	673,400,673	2,680,527,497	81.23%
2004	\$0.05	100,000,000	673,400,673	3,353,928,171	101.63%

Integrative Approaches to Molecular Biology

The Challenge:

- Do we need to begin integrating information in molecular biology?**
- Do we need people with a specific interest in integrating information?**
- Is the intuition and expertise of the experimentalist enough to provide the required integrative framework?**
- What is the role of formalization in integrative molecular biology?**

Integration is Essential

The Goals:

- Achieve an increasing conceptual integration in molecular biology, especially in comparative genomics.
- Provide a technical integration of data and analytical resources to facilitate conceptual integration.

The Impediments:

- Sociological
- Conceptual: What is a gene?
- Conceptual: Nomenclature
- Technical

The Solutions:

- ?
- ?

Some Recommendations

Meeting Report DOE Informatics Summit

*26 - 27 April 1993
Baltimore, Maryland*

Revised: 15 September 1993

Printed: 12 April 1994 at 8:31am

Genome Informatics Summit Report

Observations

The success of the genome project will increasingly depend on the ease with which accurate and timely answers to interesting questions about genomic data can be obtained.

If repeating experiments becomes easier than locating previous results, genome informatics will have failed.

All extant community databases have serious deficiencies and fall short of meeting community needs.

An embarrassment to the Human Genome Project is our inability to answer simple questions such as, "How many genes on the long arm of chromosome 21 have been sequenced?"

Sample Integrated Genome Queries

- Return all sequences which map 'close' to marker M on human chromosome 19, are putative members of the olfactory receptor family, and have been mapped on a contig map of the region; return also the contig descriptions. (This is nominally a link between GenBank, GDB, and LLNL's databases.)
- Return all genomic sequences for which alu elements are located internal to a gene domain.
- Return the map location, where known, of all alu elements having homology greater than "h" with the alu sequence "S".
- Return all human gene sequences, with annotation information, for which a putative functional homologue has been identified in a non vertebrate organism; return also the GenBank accession number of the homologue sequence where available.
- Return all mammalian gene sequences for proteins identified as being involved in intra cellular signal transduction; return annotation information and literature citations.
- Return any annotation added to my sequence number ##### since I last updated it.
- Return the genes for zinc-finger proteins on chromosome 19 that have been sequenced. (Note that answering this requires either query by sequence similarity or uniformity of nomenclature.)
- Return the number and a list of the distinct human genes that have been sequenced.
- Return all the human contigs greater than 150 kb.
- Return all sequences, for which at least two sequence variants are known, from regions of the genome within +/- one chromosome band of DS14###.
- Return all publications from the last two years about my favorite gene, accession number X####.
- Return all G1/S serine/threonine kinase genes (and their translated proteins) that are known (experimentally) or are thought (by similarity) also to exhibit tyrosine phosphorylation activity. Keep clear the distinction in the output.

Comparative Genomic Techniques

Map Dot Plot

Homologous-Locus Position Comparison

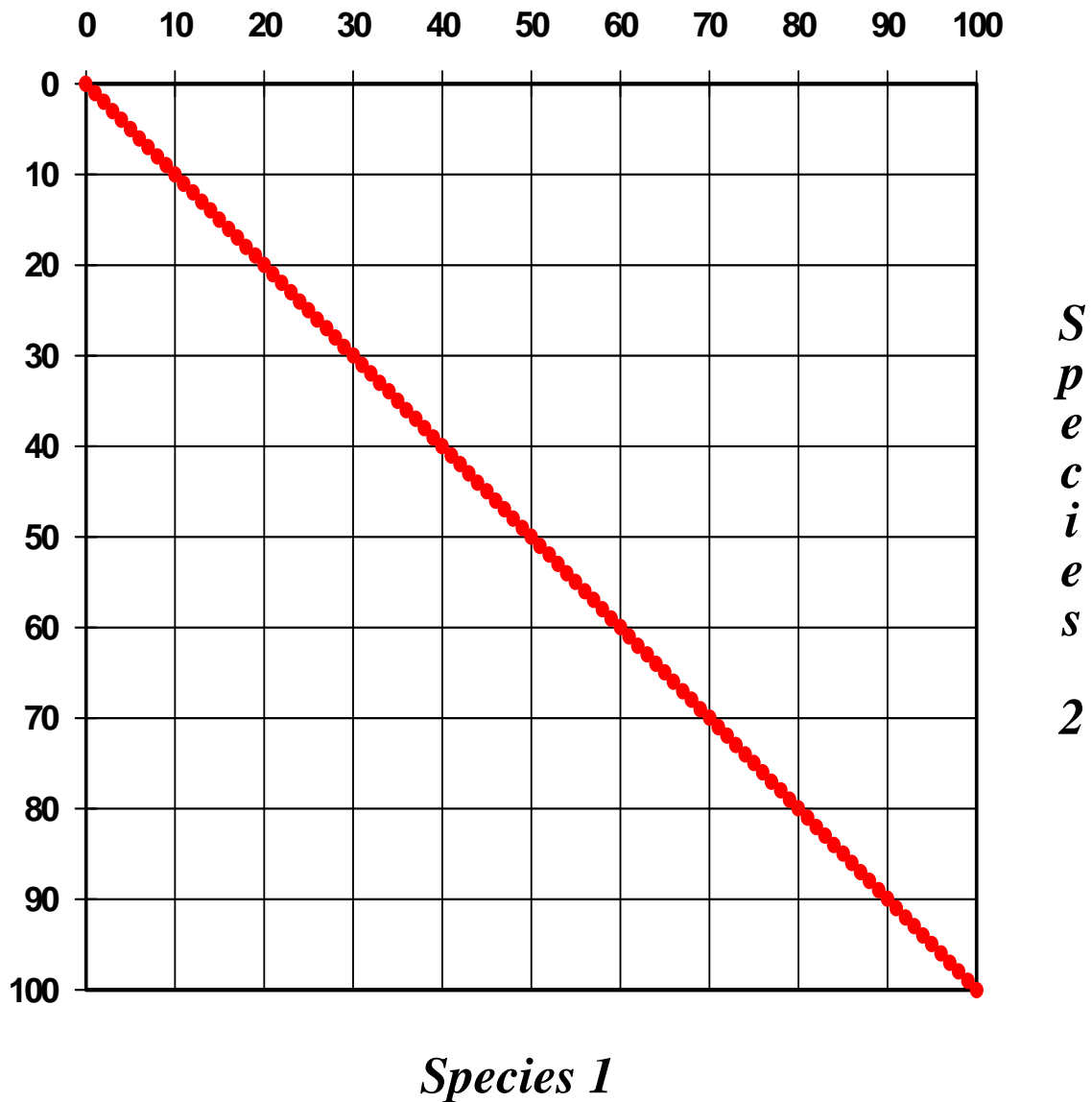

perfect congruence

Map Dot Plot

Homologous-Locus Position Comparison

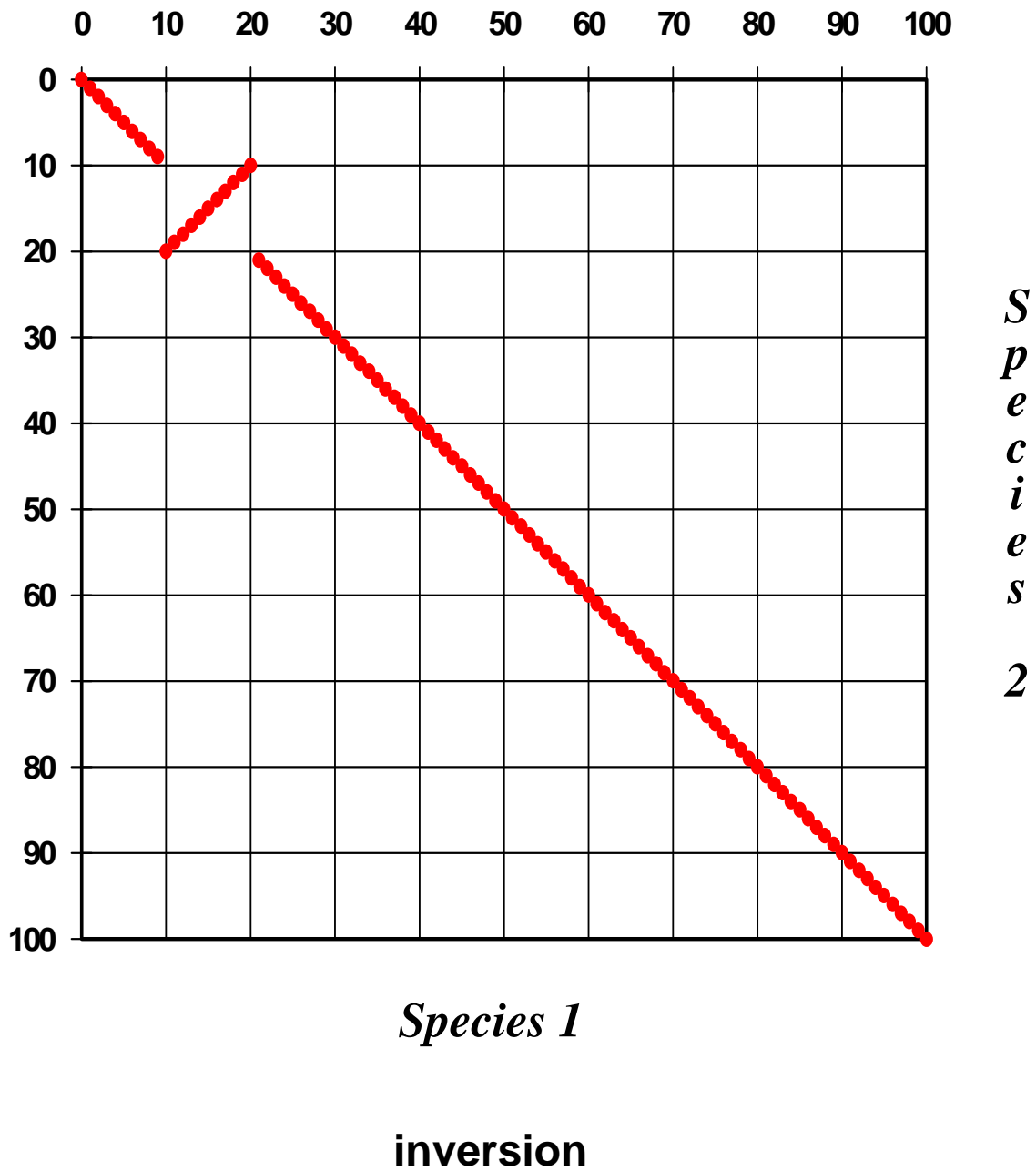

Map Dot Plot

Homologous-Locus Position Comparison

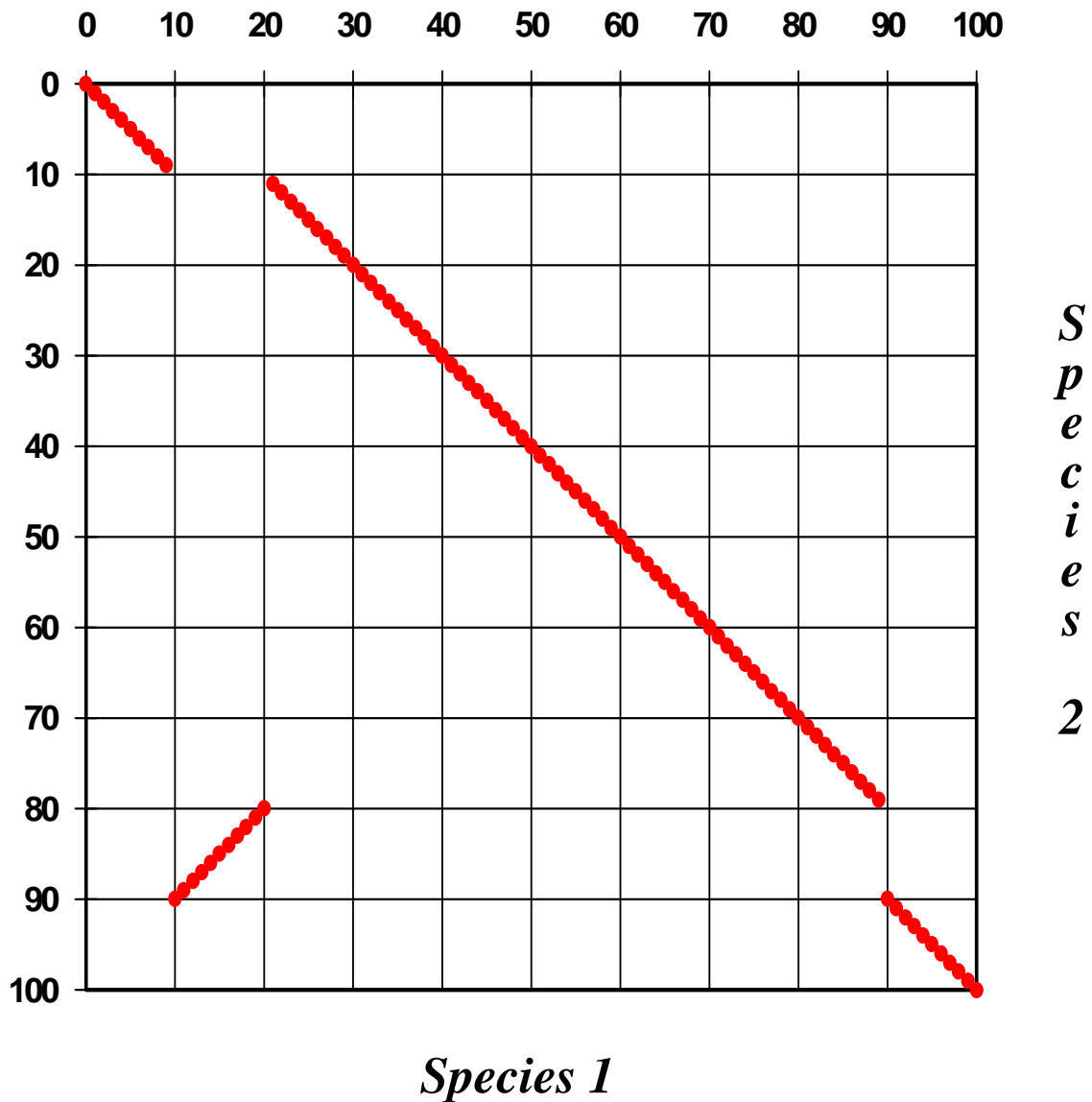

translocation and inversion

Map Dot Plot

Homologous-Locus Position Comparison

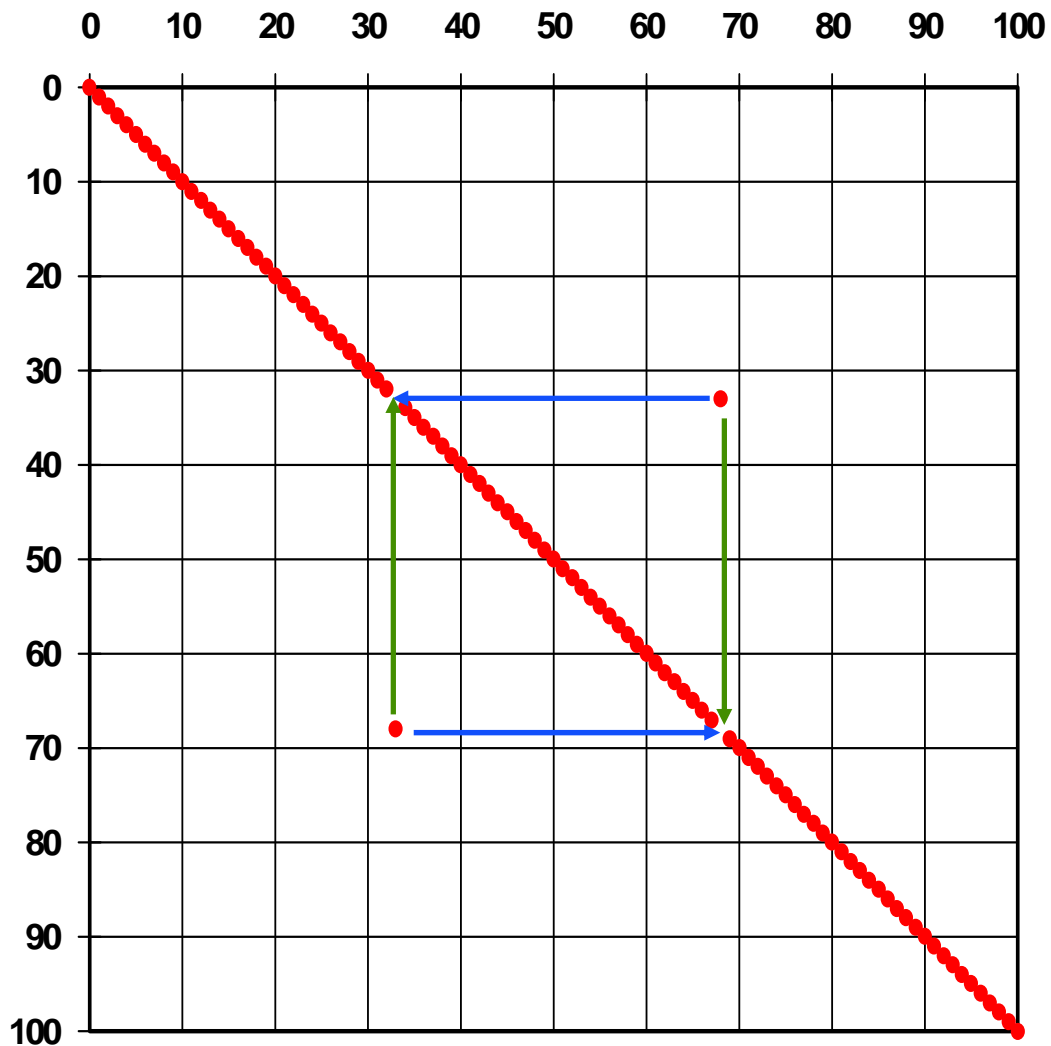

S
p
e
c
i
e
s

2

Species 1

homology error

Map Dot Plot

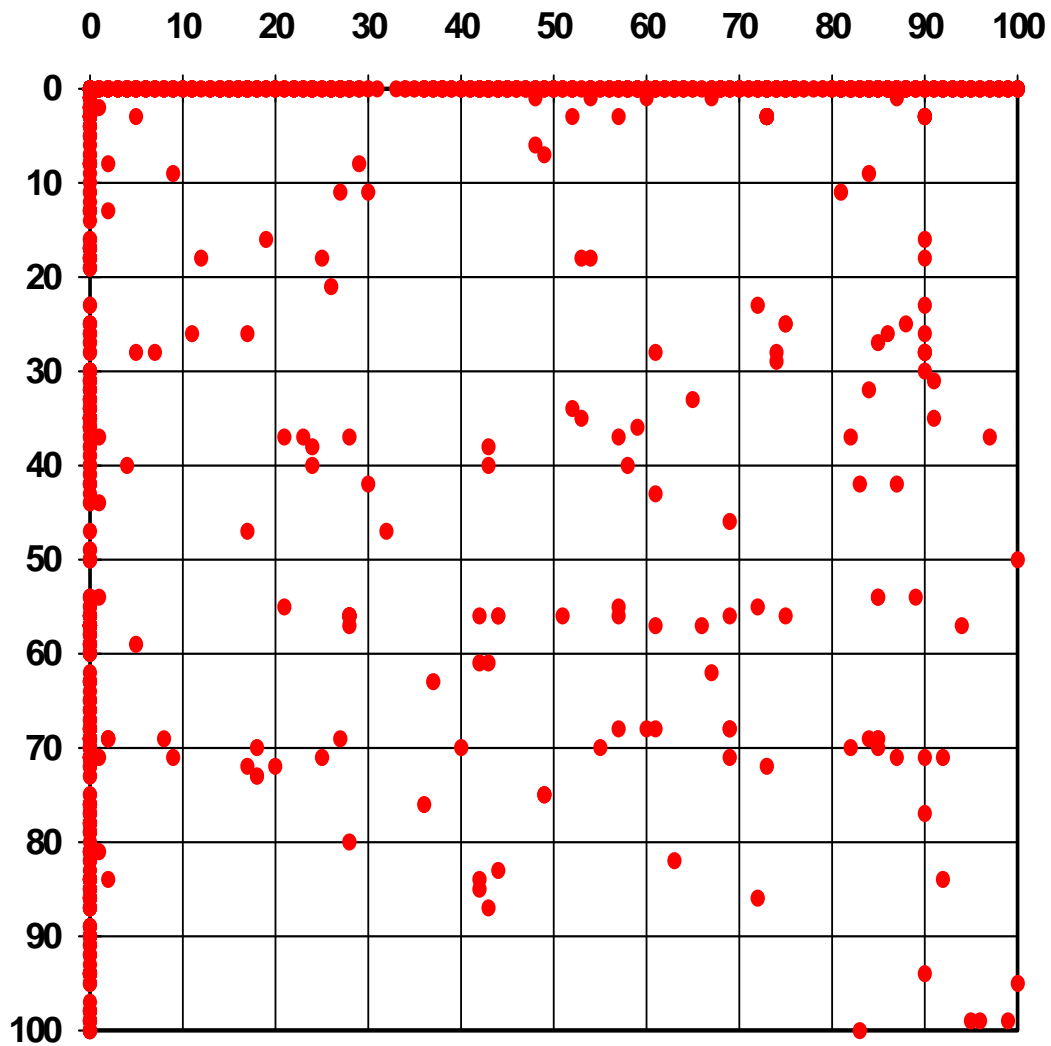

E. coli

E. coli vs *B. subtilis*

Map Dot Plot

Homologous-Locus Position Comparison

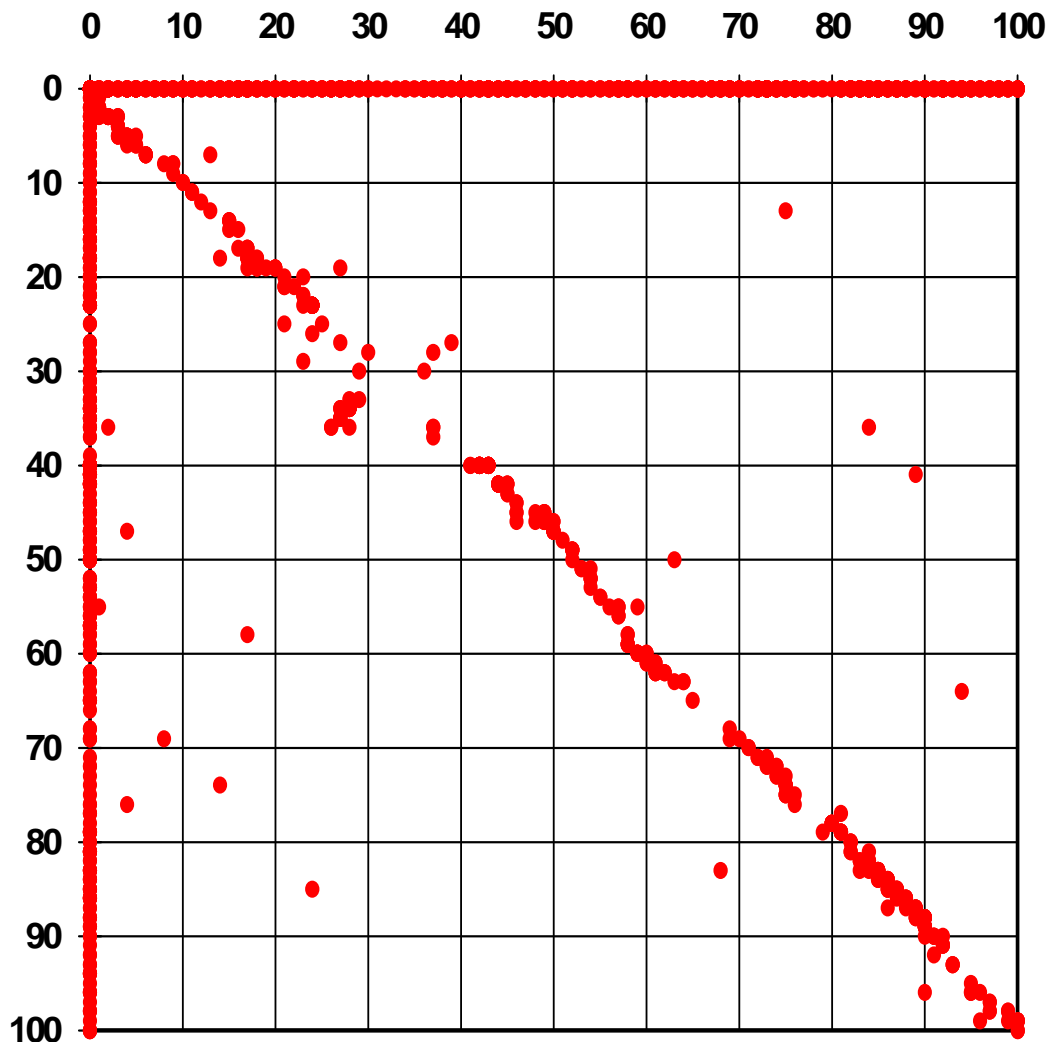

E. coli

E. coli vs *S. typhimurium*

Data from:

Abel, Y., and Cedergren, R. 1990. The Normalized Gene Designation Database

Map Dot Plot

Homologous-Locus Position Comparison

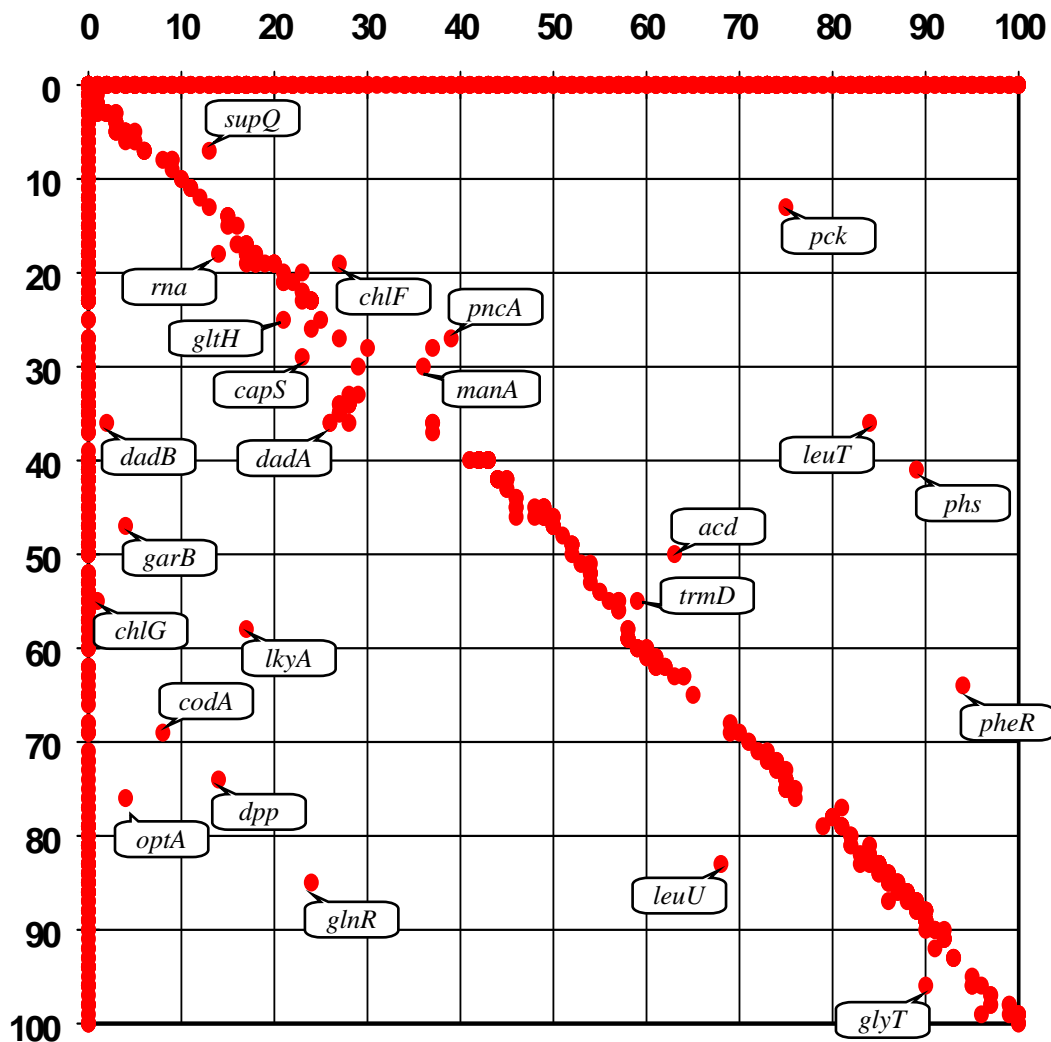

E. coli

E. coli vs *S. typhimurium*

Data from:

Abel, Y., and Cedergren, R. 1990. The Normalized Gene Designation Database

Sociological Impediments

Data Sharing -- Not a New Problem

Newton ... clashed with the Astronomer Royal, John Flamsteed, who had earlier provided Newton with much needed data for Principia, but was now withholding information that Newton wanted. Newton would not take no for an answer; he had himself appointed to the governing body of the Royal Observatory and then tried to force immediate publication of the data. Eventually he arranged for Flamsteed's work to be seized and prepared for publication by Flamsteed's mortal enemy, Edmond Halley. But Flamsteed took the case to court and, in the nick of time, won a court order preventing distribution of the stolen work. Newton was incensed and sought his revenge by systematically deleting all references to Flamsteed in later editions of Principia.

Hawking, Stephen W. 1988. *A Brief History of Time*. New York: Bantam Books. p. 181

Conceptual Impediments I What is a Gene?

Significant Errors

If the genes are conceived as chemical substances, only one class of compounds need be given to which they can be reckoned as belonging, and that is the proteins in the wider sense, on account of the inexhaustible possibilities for variation which they offer. ... Such being the case, the most likely role for the nucleic acids seems to be that of the structure-determining supporting substance.

T. Caspersson. 1936. Über den chemischen Aufbau der Strukturen des Zellkernes. *Acta Med. Skand.*, 73, Suppl. 8, 1-151.

Fifty years from now it seems very likely that the most significant development of genetics in the current decade (1945-1955) will stand out as being the discovery of pseudoallelism.

Glass, B., 1955, Pseudoalleles, *Science*, 122:233.

The ultimate ... man [will be] the complete DNA sequence

Committee on Mapping and Sequencing the Human Genome, 1988, *Mapping and Sequencing the Human Genome*. National Academy Press, Washington, D.C., p. 6.

What is a Gene?

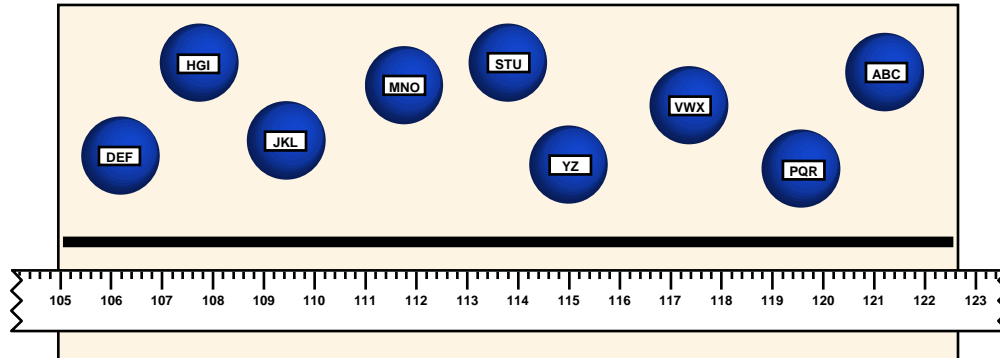

The beads can be conceptually separated from the string, which has “addresses” that are independent of the beads.

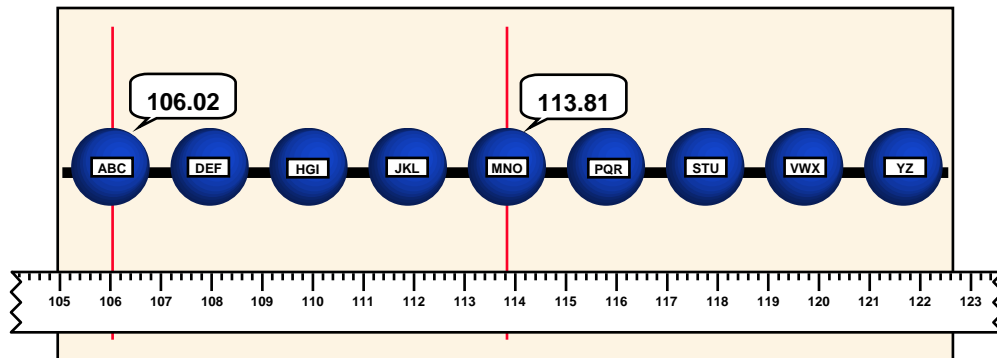

Mapping involves placing the beads in the correct order and assigning a correct address to each bead. The address assigned to a bead is its locus.

The genes are arranged in a manner similar to beads strung on a loose string.

Sturtevant, A.H., and Beadle, G.W., 1939, *An Introduction to Genetics*. W. B. Saunders Company, Philadelphia, p. 94.

What is a Gene?

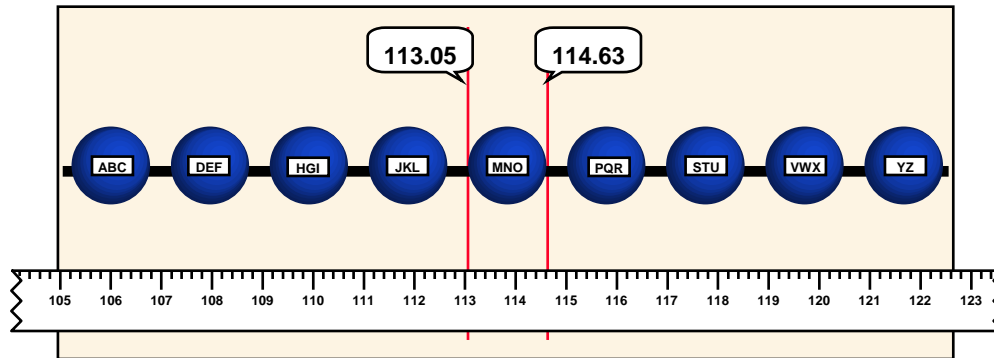

Recognizing that the beads have width, mapping could be extended to assigning a pair of numbers to each bead so that a locus is defined as a region, not a point.

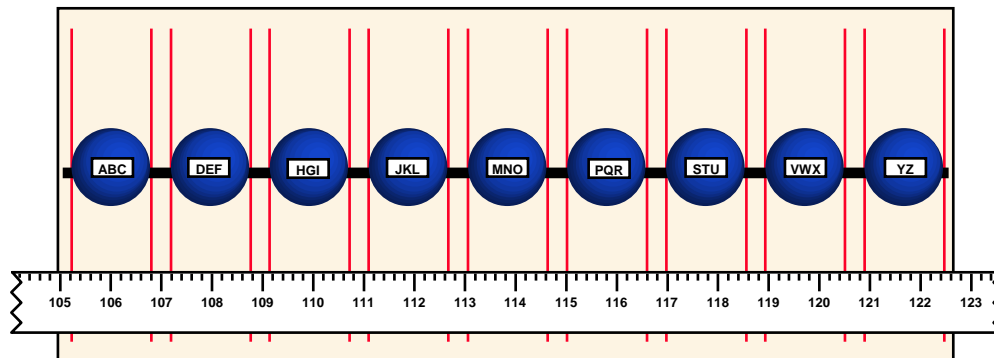

In this model, genes are independent, mutually exclusive, non-overlapping entities, each with its own absolute address.

What is a Gene?

Classical Definition: fundamental unit of heredity, mutation, and recombination (beads on a string).

Physiological Definition: fundamental unit of function (one gene, one enzyme).

Cistronic Definition: fundamental unit of expression (cis-trans test).

Sequence Definition: the smallest segment of the gene-string consistently associated with the occurrence of a specific genetic effect.

Current Definition: ???

Gene (cistron) is the segment of DNA involved in producing a polypeptide chain; it includes regions preceding and following the coding region (leader and trailer) as well as intervening sequences (introns) between individual coding segments (exons).

Allele is one of several alternative forms of a gene occupying a given locus on a chromosome.

Locus is the position on a chromosome at which the gene for a particular trait resides; locus may be occupied by any one of the alleles for the gene.

Lewin, Benjamin. 1990. *Genes IV*. Oxford University Press, New York.

What is a Gene?

The unexpected features of eukaryotic genes have stimulated discussion about how a gene, a single unit of hereditary information, should be defined. Several different possible definitions are plausible, but no single one is entirely satisfactory or appropriate for every gene.

Singer, M., and Berg, P. *Genes & Genomes*.
University Science Books, Mill Valley, California.

The Simplistic View of a Genome

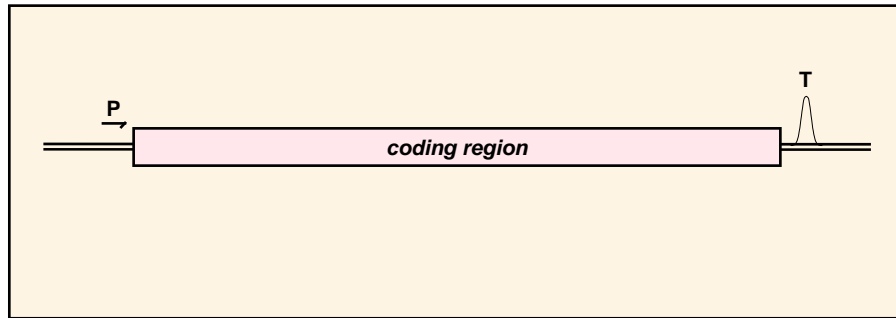

A gene is a transcribed region of DNA, flanked by upstream start regulatory sequences and downstream stop regulatory sequences.

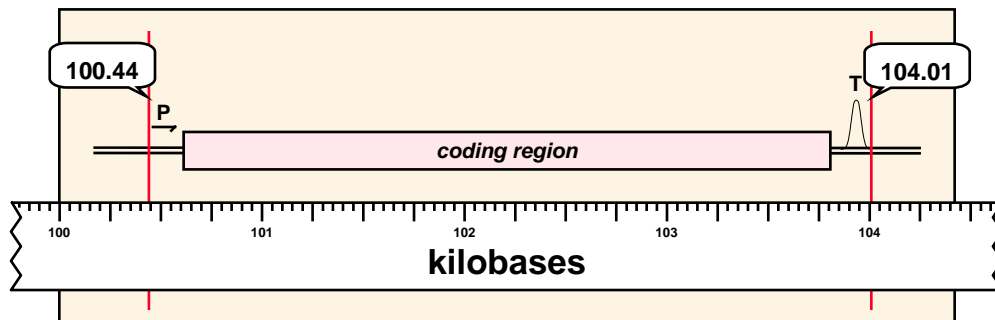

The location of a gene can be designated by specifying the base-pair location of its beginning and end.

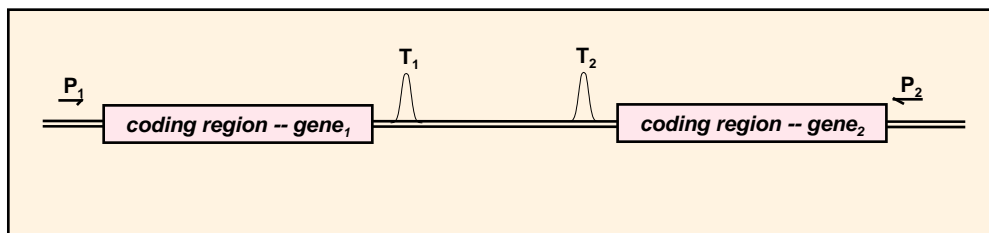

DNA may be transcribed in either direction. Therefore, fully specifying a gene's position requires noting its orientation as well as its start and stop positions.

The Simplistic View of a Genome

A naive view holds that a genome can be represented as a continuous linear string of nucleotides, with landmarks identified by the chromosome number followed by the offset number of the nucleotide at the beginning and end of the region of interest. This simplistic approach ignores the fact that human chromosomes may vary in length by tens of millions of nucleotides.

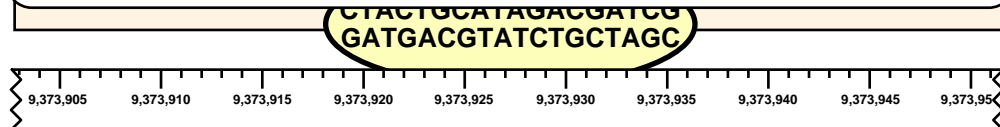

Complex Genomic Regions

Escherichia coli: the MMS Operon

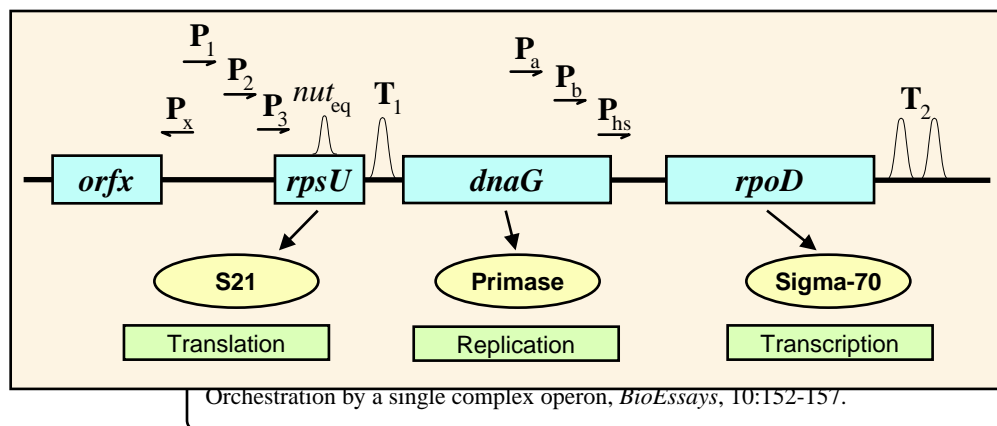

Drosophila melanogaster: The Gart Locus

Fragmented Genes

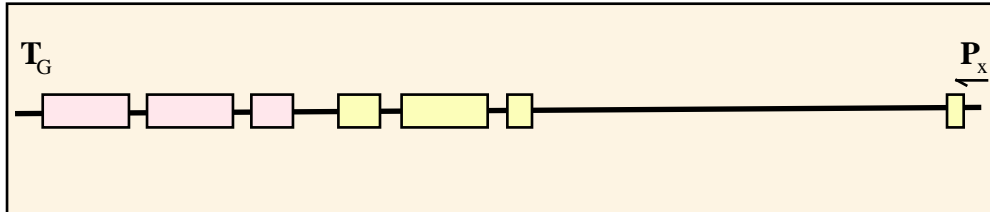

Alternative Splicing

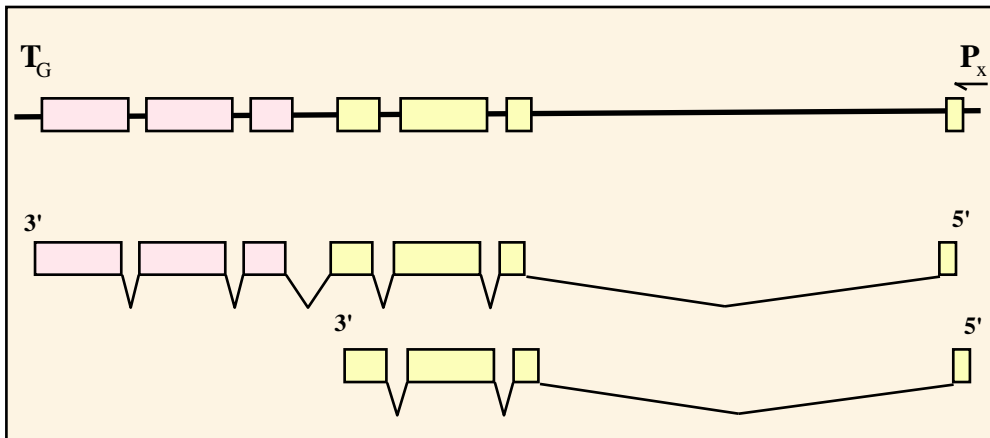

Nested Genes

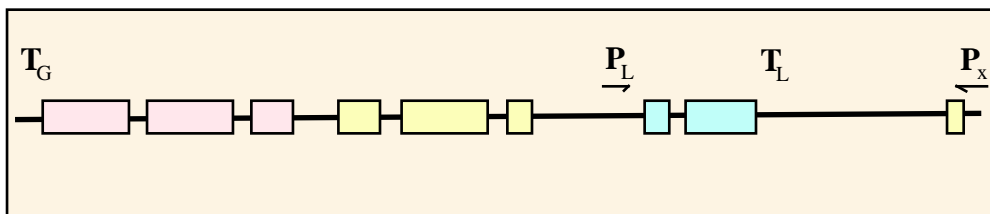

unrelated proteins on opposite strands, *Cell* 44:33.

Nested Gene Families

Homo sapiens: The UGT1 Loci

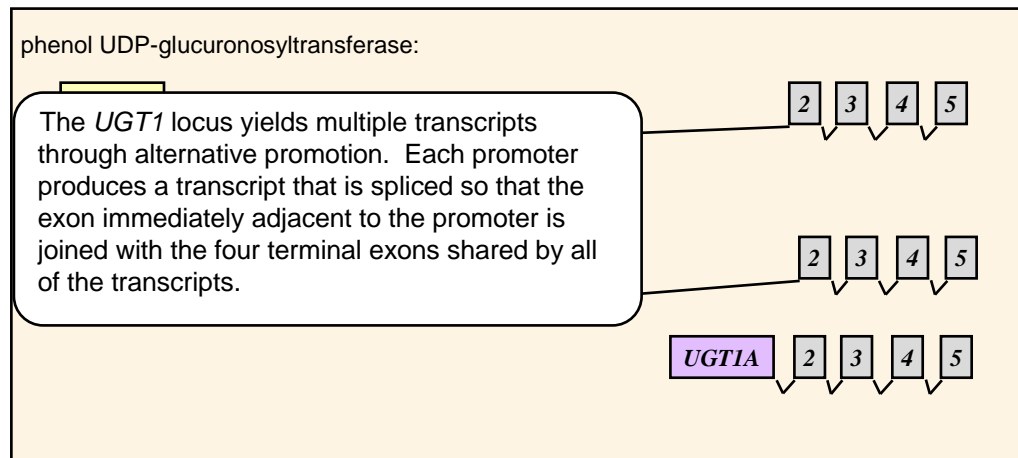
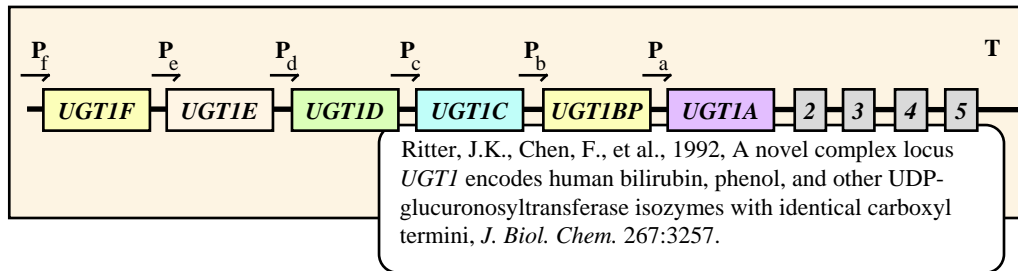

Other Complexities

Multiple Gene Products

Homo sapiens: The POMC Locus

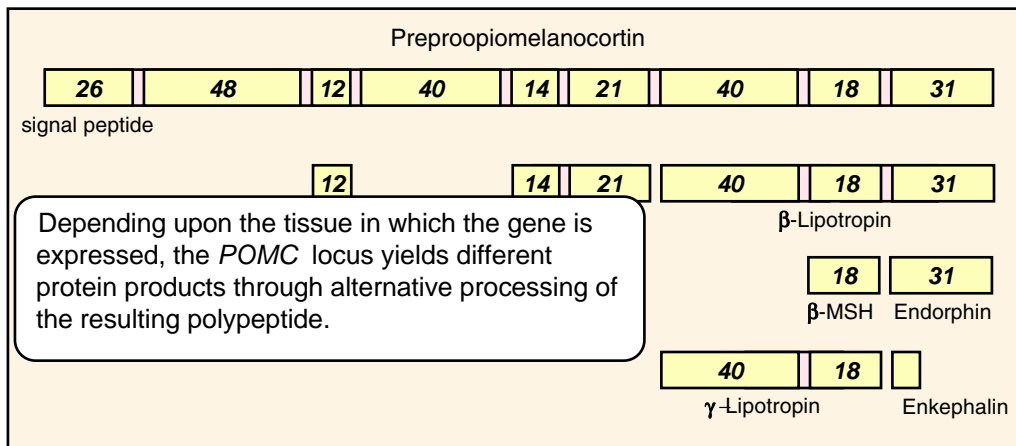

VNTR Loci

D14S1: Frequency of PstI fragment sizes (kb)

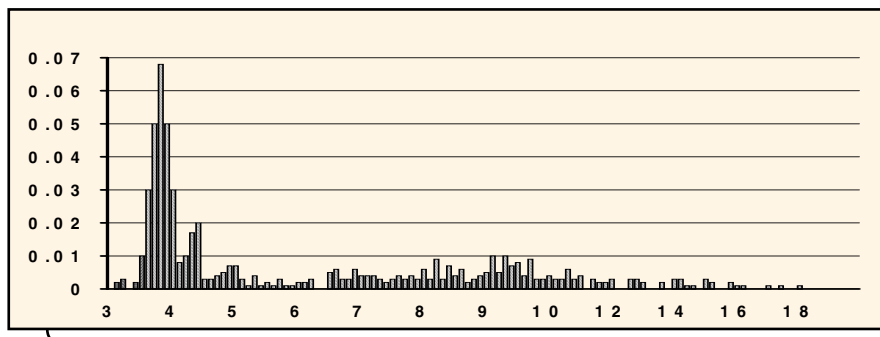

What is a Gene?

For the purposes of this book, we have adopted a molecular definition. A eukaryotic gene is a combination of DNA segments that together constitute an expressible unit, expression leading to the formation of one or more specific functional gene products that may be either RNA molecules or polypeptides.

Singer, M., and Berg, P. *Genes & Genomes*. University Science Books, Mill Valley, California.

DNA molecules (chromosomes) should thus be functionally regarded as linear collections of discrete transcriptional units, each designed for the synthesis of a specific RNA molecule. Whether such “transcriptional units” should now be redefined as genes, or whether the term *gene* should be restricted to the smaller segments that directly code for individual mature rRNA or tRNA molecules or for individual polypeptides is a question.

Watson, J. D., Hopkins, N. H., Roberts, J. W., Steitz, J. A., and Weiner, A. M. 1992. *Molecular Biology of the Gene*. Benjamin/Cummins Publishing Company: Menlo Park, California. p. 233.

What is a Map?

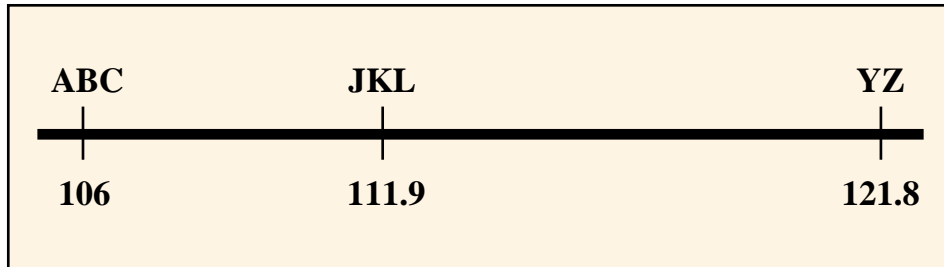

According to the beads on a string model, maps of a few genes might be represented by showing the gene names in order, with their relative positions indicated. And that is exactly the way the first genomic map was represented.

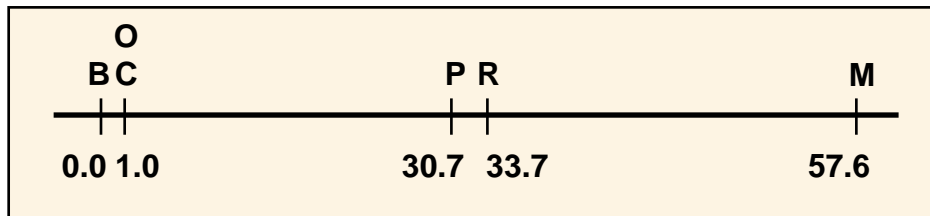

B = yellow body
C = white eye
O = eosin eye

Sturtevant, A.H., 1913, The linear arrangement of six sex-linked factors in *Drosophila* as shown by their mode of association. *Journal of Experimental Zoology*, 14:43-59.

P = vermilion eye
R = rudimentary wing
M = miniature wing

B, $\frac{O}{M}$, P, R, C

What is a Map?

Appropriate Data Structures

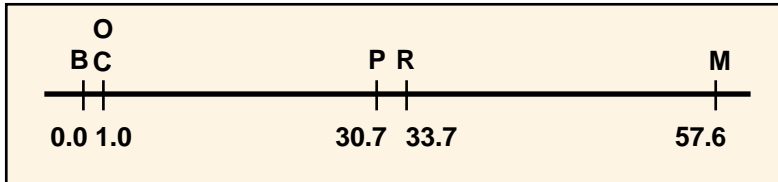

gene	locus
B	0.0
C	1.0
O	1.0
P	30.7
R	33.7
M	57.6

Many geneticists still think of maps as ordered lists, and ordered list representations are used in many genome databases..

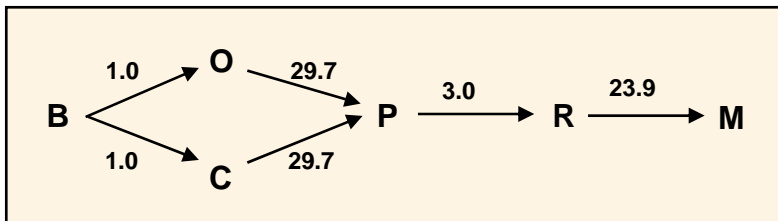

arc	length
B, O	1.0
B, C	1.0
O, P	29.7
C, P	29.7
P, R	3.0
R, M	23.9

Directed acyclic graph (DAG) data structures can be represented pictorially (above) or tabularly (right). Depending on their use, DAGS may be represented as transitive reductions (above) or transitive closures (below).

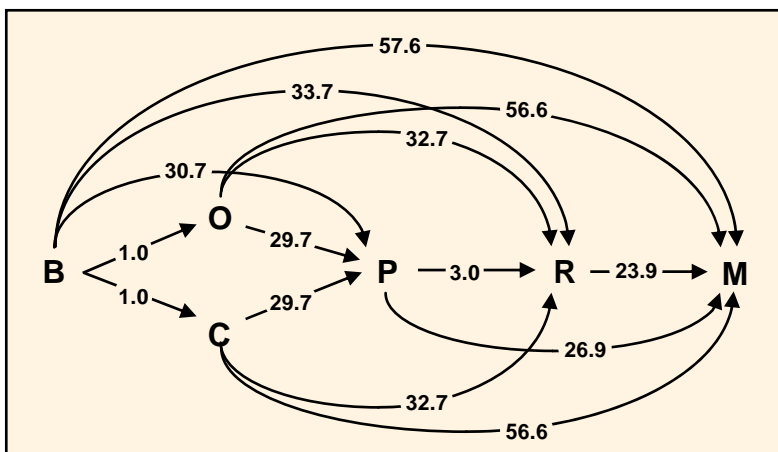

arc	length
B, O	1.0
B, C	1.0
B, P	30.7
B, R	33.7
B, M	57.6
O, P	29.7
O, R	32.7
O, M	56.6
C, P	29.7
C, R	26.9
C, M	56.6

**Conceptual
Impediments
II
Genetic
Nomenclature**

Comparative Database

Content

E. coli	=	1,391
S. typhimurium	=	754
S. cerevisiae	=	1,427
C. elegans	=	229
D. melanogaster	=	5,684
Z. mays	=	1,035
A. thaliana	=	236
M. musculus	=	1,361
H. sapiens	=	4,383
		=====
		16,500

A comparative database was assembled by collecting data on genetic markers from a variety of organisms.

Comparative Database

Structure

```
START RECORD:
  Taxon: S. typhimurium
  Id:
  Symbol: aceA
  Name: Acetate
  Old_symbol:
  Position: 89
  Prod_func: Growth on acetate or
fatty acids
  Enzyme: isocitrate lyase
  Ec_num: 4.1.3.1
  Comment:
END RECORD:
```

The data were converted into a comparable format...

Gene Nomenclature Problems

Identical symbols / different meaning

SYMBOL: ACD

acd:	E. coli
Name:	Acetaldehyde CoA deHase
acd:	Arabidopsis
Name:	accelerated cell death
acd:	M. musculus
Name:	adrenocortical dysplasia

SYMBOL: AG

ag:	D. melanogaster
Name:	agametic
ag:	Arabidopsis
Name:	agamous (floral defective)

SYMBOL: CHS1

CHS1:	H. sapiens
Name:	Cohen syndrome 1
Map:	Unassigned
CHS1:	S. cerevisiae
Name:	Chitin synthetase
Enzyme:	chitin synthase.
EC Number:	2.4.1.16

Gene Nomenclature Problems

Case and Name Differences
Some Functional Similarities
Some Functional Differences
All Confusing

SYMBOL: CAL

cal: D. melanogaster
Name: coal
Map: 3 59.5.

Cal: D. melanogaster
Name: Calmodulin
Map: 2 [64]
Prod_Func: calmodulin

cal: C. elegans
Name: CALmodulin related

cal: Arabidopsis
Name: cauliflower (defective inflorescence)

Gene Nomenclature Problems

Case and Name Differences
Some Functional Similarities
Some Functional Differences
All Confusing

SYMBOL: CAT

Cat: D. melanogaster
Name: Catalase
Map: 3 47.0
Enzyme: catalase
EC Number: 1.11.1.6

CAT: H. sapiens
Name: catalase
Map: 11p13
Enzyme: catalase
EC Number: 1.11.1.6

cat: C. elegans
Name: CATecholamine abnormality

Cat: M. musculus
Name: dominant cataract
Map: 10

SYMBOL: CAT1

cat1: Z. mays
Name: catalase1
Map: Genetic Map of Chr#5 17
Enzyme: catalase
EC Number: 1.11.1.6

cat1: S. cerevisiae
Name: Catabolite repression
Map: 4R303

Gene Nomenclature Problems

*Same symbol / same name
No Homology*

SYMBOL: DW

dw: D. melanogaster
Name: dwarf
Map: 3 50.

dw: M. musculus
Name: dwarf
Map: 16

*Same symbol / different name
All Phenomenology*

SYMBOL: FT

ft: D. melanogaster
Name: fat
Map: 2 12.0.
Prod_Func: cadherin

ft: Arabidopsis
Name: late flowering

ft: M. musculus
Name: flaky tail
Map: 3

Gene Nomenclature Problems

Case Differences *Subtle Name Differences* *Functional Similarity*

SYMBOL: GAD1

Gad1:	D. melanogaster
Name:	Glutamic acid decarboxylase 1
EC Number:	4.1.1.15

GAD1:	H. sapiens
Name:	glutamate decarboxylase 1 (brain, 67kD)
EC Number:	4.1.1.15

Comparative Database

SYMBOL: A

a: arc

A: Abnormal abdomen

SYMBOL: AA

aa: anarista

Aa: Altered abdomen

SYMBOL: AE

ae: aeroplane

Ae: Aechna

SYMBOL: ALD

ald: altered disjunction

Ald: Aldolase

SYMBOL: APX

apx: apexless

Apx: Antennapedex

SYMBOL: AT

at: arctus oculus

At: Attenuated

SYMBOL: B

b: black

B: Bar

In *Drosophila*, there are 134 gene pairs with gene symbols that differ only in their use of case.

Comparative Database

EC Numbers As a Solution?

- 3886 - Number of pairs of loci in different species with same EC number**
- 105 - Number of these pairs with same gene symbol (exact)**
- 183 - Number of these with same gene symbol (ignoring case)**

Comparative Database

*EC Numbers
As a Solution?*

CONDITION: enzyme = PIR

(case sensitive)

**1824 - Total number of records with
EC numbers**

**54 - Number with enzyme name
matching PIR database**

CONDITION: enzyme = PIR

(case insensitive)

**1824 - Total number of records with
EC numbers**

**250 - Number with enzyme name
matching PIR database**

Comparative Database

*EC Numbers
As a Solution?*

CONDITION: enzyme = PIR
(case/hyphen insensitive)

**1824 - Total number of records with
EC numbers**

**314 - Number with enzyme name
matching PIR database**

CONDITION: enzyme = PIR
(case/hyphen/substring insensitive)

**1824 - Total number of records with
EC numbers**

**411 - Number with enzyme name
matching PIR database**

A Modest Proposal

Enzyme Commission History

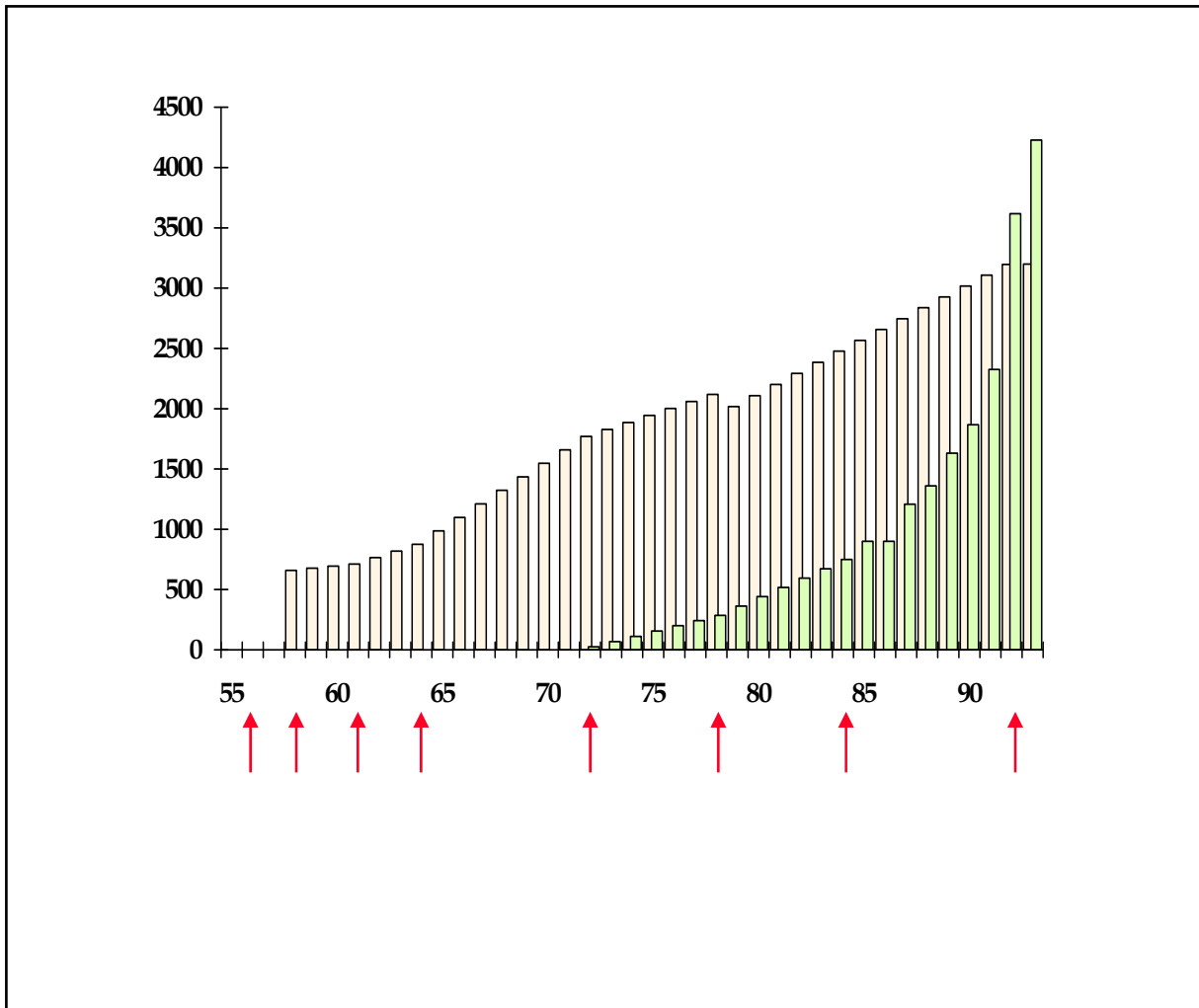

**Cumulative Totals
Known Enzymes
Human Genes**

Why an Enzyme Commission

[M]any other workers were inventing names for new enzymes, and there was a widespread view that the results were chaotic and unsatisfactory. In many cases the enzymes became known by several different names, while conversely the same name was sometimes given to different enzymes. Many of the names conveyed little or no idea of the nature of the reactions catalyzed, and similar names were sometimes given to enzymes of quite different types.

Webb, E. C. 1993. Enzyme nomenclature: A personal retrospective. *The FASEB Journal*, 7:1192-1194.

Why an Enzyme Commission

A major part of this assignment was to see how the nomenclature of enzymes could best be brought into a satisfactory state and whether a code of systematic rules could be devised that would serve as a guide for the consistent naming of new enzymes in the future. ... [T]he overriding consideration was to reduce the confusion and to prevent further confusion from arising. This task could not have been accomplished without causing some inconvenience, for this was the inevitable result of not tackling the problem earlier." (p. 1193)

Webb, E. C. 1993. Enzyme nomenclature: A personal retrospective. *The FASEB Journal*, 7:1192-1194.

Estimates of Success

Strong Recommendations:

In this context it is appropriate to express disapproval of a loose and misleading practice that is found in the biological literature. It consists in designation of a natural substance ... that cannot be described in terms of a definite chemical reaction, by the name of the phenomenon in conjugation with the suffix *-ase*... Some recent examples of such *phenomenase* nomenclature, which should be discouraged even if there are reasons to suppose that the particular agent may have enzymatic properties, are: *permease*, *translocase*, *replicase*, ... etc.

Enzyme Nomenclature, 1984

Actual Results:

permease	520
translocase	160
replicase	362

Number of papers returned on a search of MedLine from 1986 - 1993.

A Modest Proposal

There will come a time when all the plant forms in existence will have been described; when herbaria will contain indubitable material of them; when botanists will have made, unmade, often remade, raised, or lowered, and above all modified several hundred thousand taxa ranging from classes to simple varieties, and when synonyms will have become much more numerous than accepted taxa. Then science will have need of some great renovation of its formulae. This nomenclature which we now strive to improve will then appear like an old scaffolding, laboriously patched together and surrounded and encumbered by the debris of rejected parts. The edifice of science will have been built but the rubbish incident to its construction not cleared away. Then perhaps there will arise something wholly different from Linnaean nomenclature, something so designed as to give certain and definite names to certain and definite taxa.

That is the secret of the future, a future still very far off.

In the meantime, let us perfect the binomial system introduced by Linnaeus. Let us try to adapt it better to the continual, necessary changes in science ... drive out small abuses, the little negligences and, if possible, come to agreement on controversial points. thus

we shall prepare
taxonomy.

Alphonse de Candolle, 1867, *Laws of Botanical Nomenclature*, quoted in
Nicolson, D. H. 1991. A history of botanical nomenclature. *Annals of the
Missouri Botanical Garden*, 78:33-56

Technical Impediments

Genome Informatics Requirements and Challenges

Requirements

Challenges

Data Acquisition

Design

Data Analysis

Design

Data Exchange

Design

Data Publication

Design

Data Access

Design

Data Visualization

Design

It is well known that 80% of a data processing budget is spent on maintenance. ... this cost is largely the result of inadequate database design.

Finkelstein, R. 1988. Database design: The road seldom taken. *Database Programming & Design*. 1(4):11-15.

[I]nadequate analysis and design, more than any other factor, deny programmers the chance to perform well. Programming without a precise statement of requirements or a plan for achieving those requirements is like trying to reach an unknown destination in the dark without a map.

Page-Jones, M. 1988. *The Practical Guide to Structured Systems Design*. Englewood Cliffs, New Jersey: Yourdon Press.

Building Databases - An Example

Problem:

Design a database to keep track of the buildings owned and occupied by the federal government.

How tough could it be?

The General Services Administration said last week it will discontinue development of Stride, a complex computer system to automate the Public Buildings Service. GSA has spent \$100 million since 1983 trying to make the system work -- a figure that does not include \$ 78 million spent of the system Stride was intended to replace.

GSA officials said Stride fell apart largely because of a failure to create a workable systems-integration plan for it. The most glaring problem with Stride was that it lacked an integration design. Stride went directly from the functional design to work packages without the intermediate step of a detailed design to show how all of the packages would fit together.

Levine, Arnold S. 1988. GSA razes \$100M PBS data project. *Federal Computer Week*, 2(29):1,53.

Cost of Software R & D

vendor	software revenues			amt revs to R&D		
	1987	1988	1989	1987	1988	1989
Computer Associates	649	925	1,290	84	120	168
Microsoft	301	625	691	33	75	97
Lotus	396	469	556	59	84	106
Dun & Bradstreet	200	200	435	50	50	NA
Oracle	196	425	418	22	47	46
Software AG of N America	185	221	294	37	44	59
Novell	126	200	282	9	14	28
WordPerfect	100	179	281	NA	NA	28
Ashton-Tate	267	307	265	35	52	69
Pansophic Systems	87	122	232	7	10	19
SAS Institute	135	170	205	61	77	92

Genome Informatics Summit Report

Recommendations

We must think of the computational infrastructure of genome research as a federated information infrastructure of interlocking pieces.

Each database should be designed as a component of a larger information infrastructure for computational biology.

Adding a new database to the federation should be no more difficult than adding another computer to the Internet.

Successful HGP data management requires the development of a federated information infrastructure, with data flowing electronically over networks from producers to databases to users.

Genome Informatics Summit Report

Recommendations

Any biologist should be able to submit research results to multiple appropriate databases with a single electronic transaction.

Professional data curators should be supported for community databases and, in addition, tools for direct author curation should be developed.

True, loss free data exchange can occur only if participating databases first achieve some kind of semantic parity.

When research advances change our perception of the real world, our databases must track the change or become inadequate.

Electronic Data Publishing

GDB Usage

Sessions

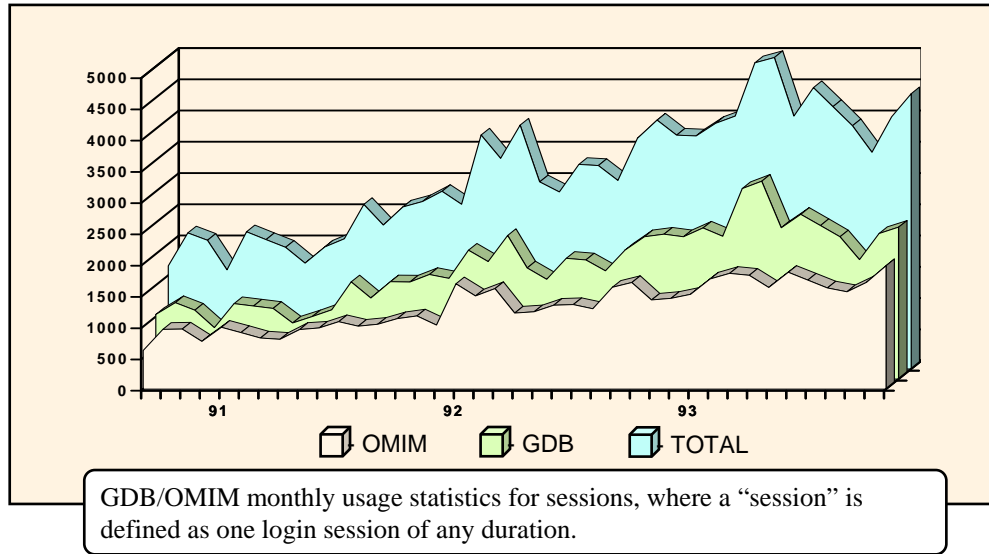

Unique Users

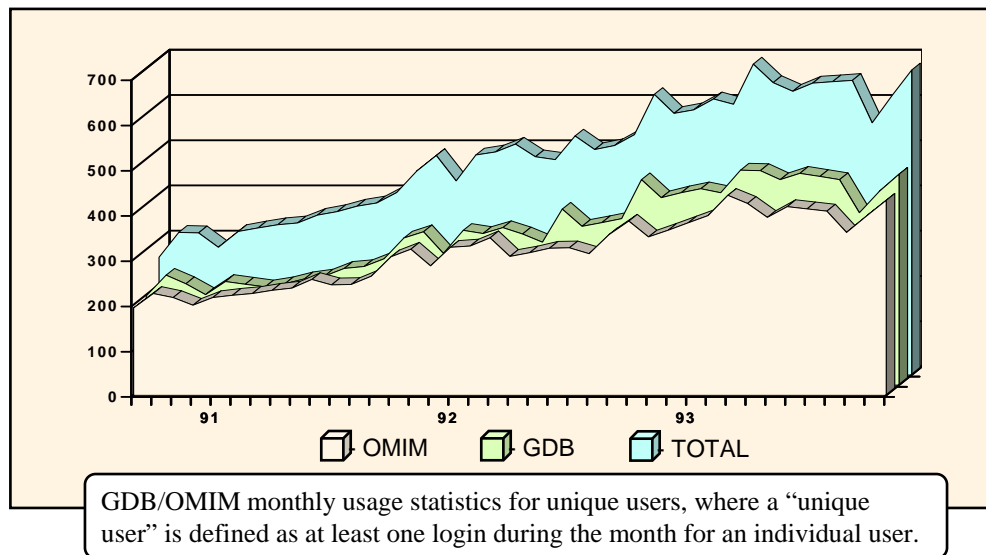

GDB Usage

Sessions (third-party software)

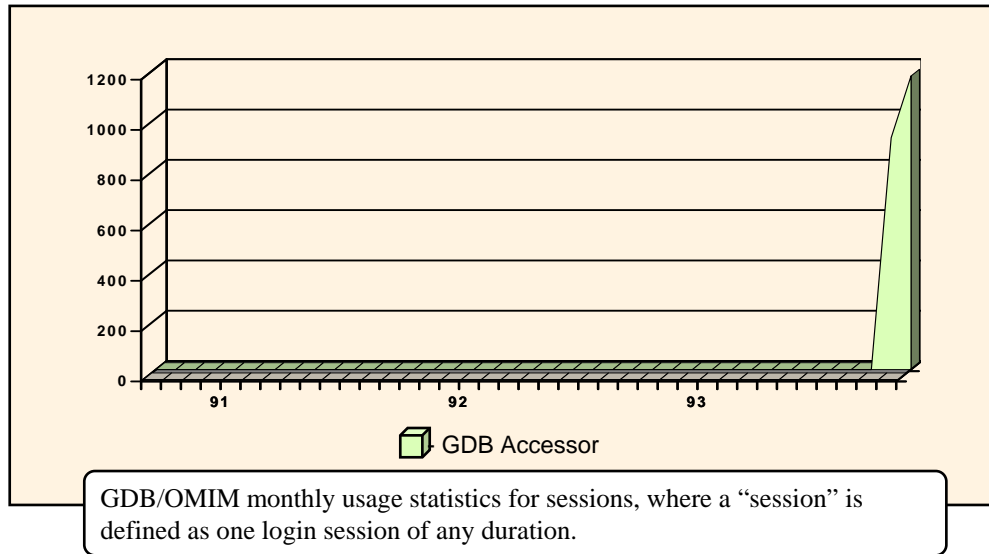

Publishing on Demand

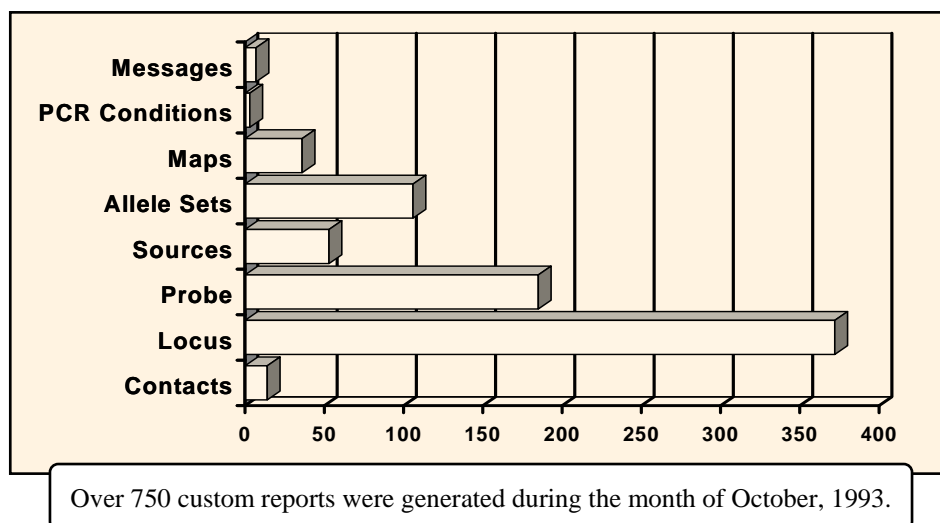

Databases as Publishing

Traditional Publishing

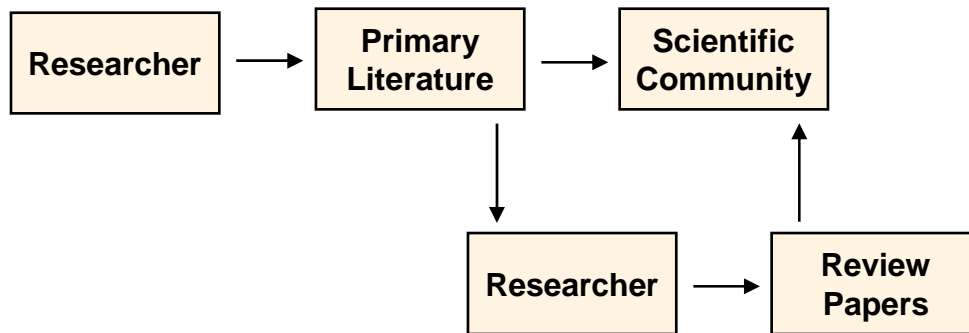

Early Database Development

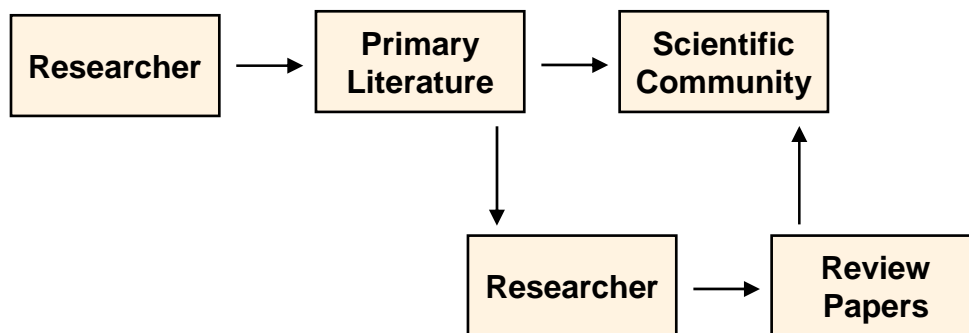

Electronic Data Publishing

Standard Database Development

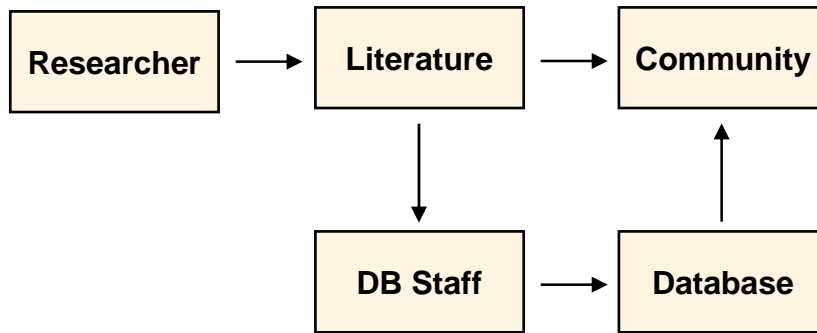

Early Electronic Data Publishing

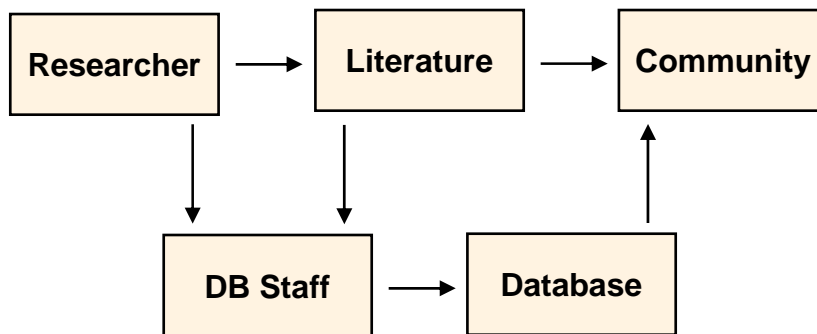

Electronic Data Publishing

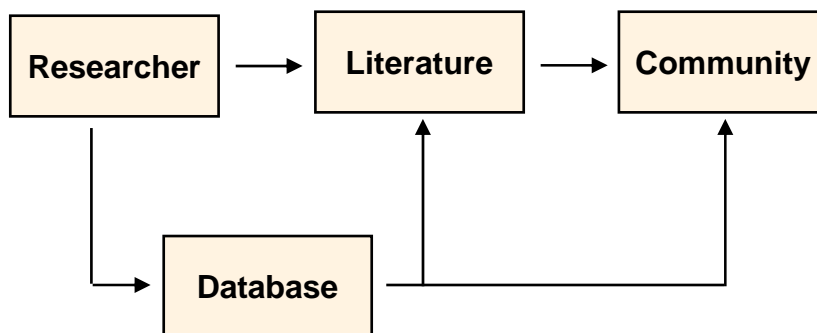

Electronic Data Publishing and Integrated Analysis

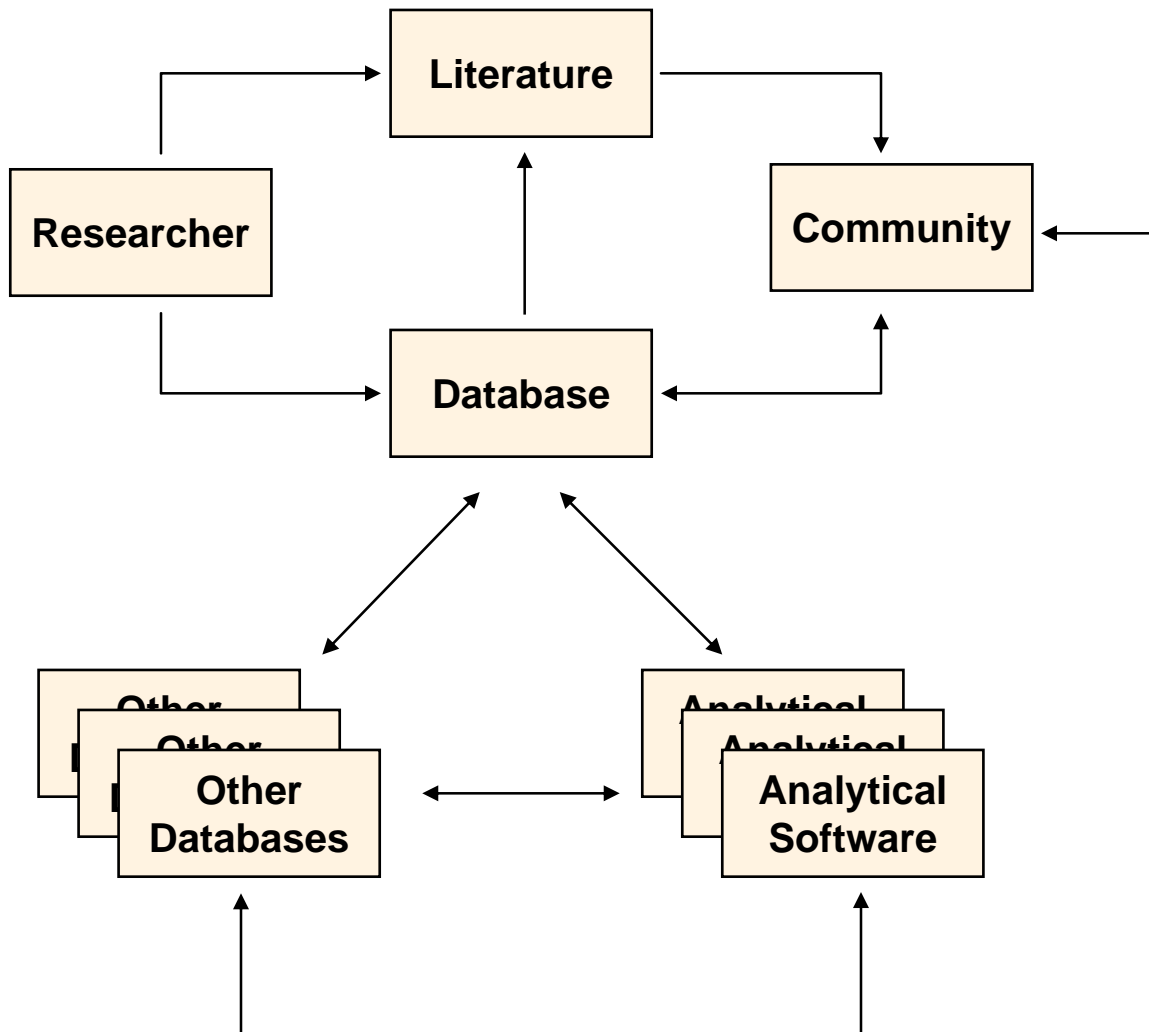

The Federation Model

The Federation Model

Originally

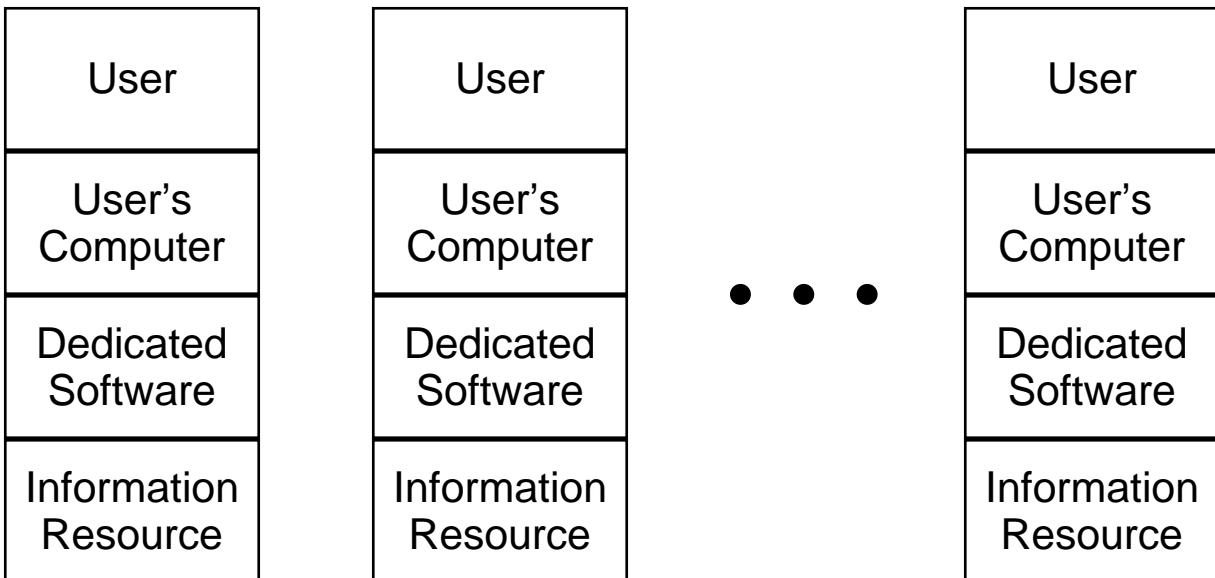
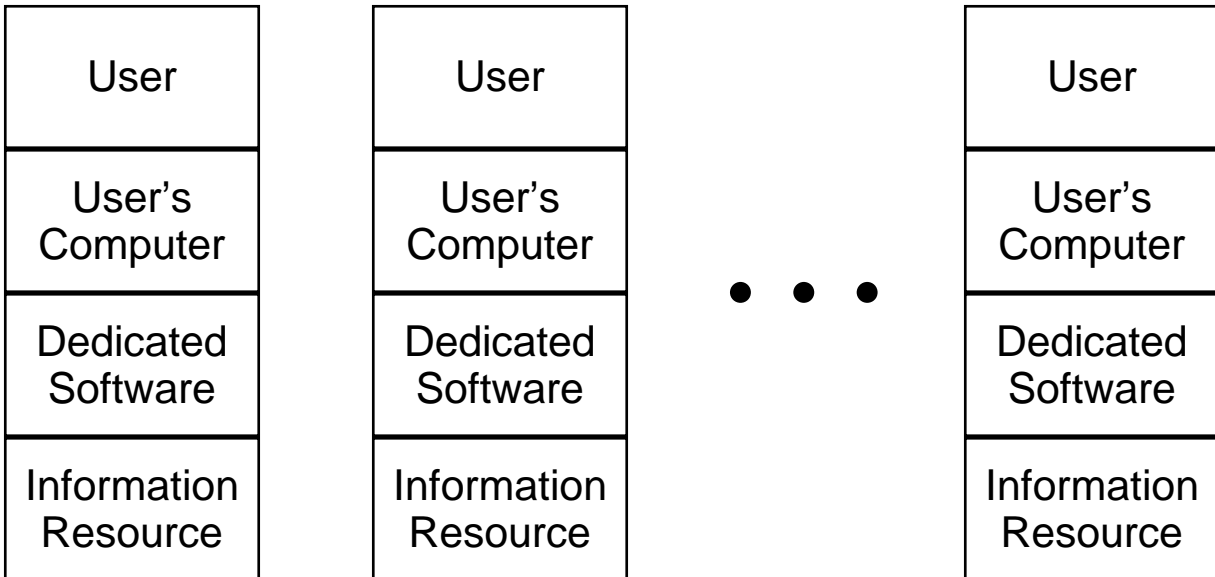

The Federation Model

Initial Client/Server Systems

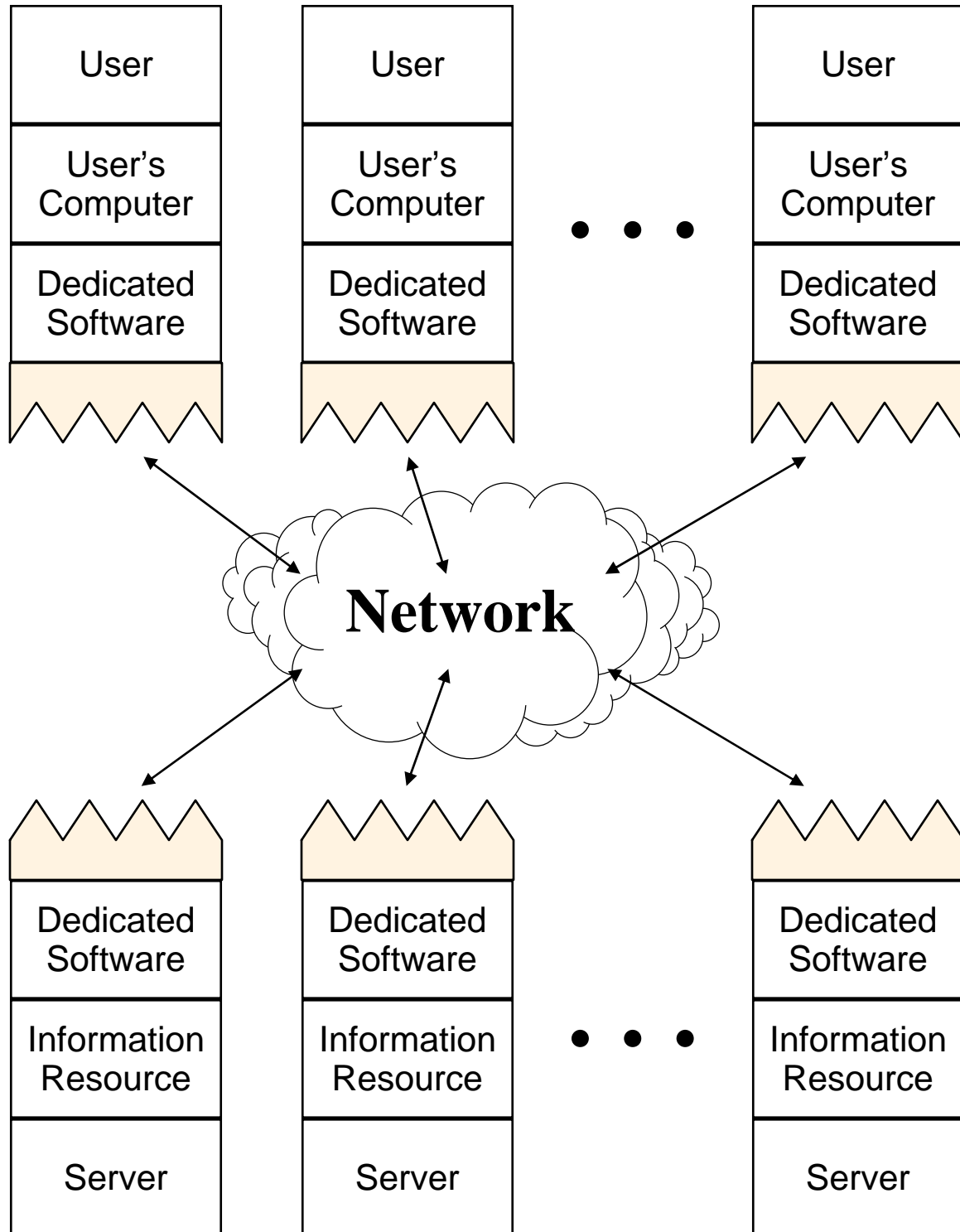

The Federation Model

Emerging Generic Client/Server Systems

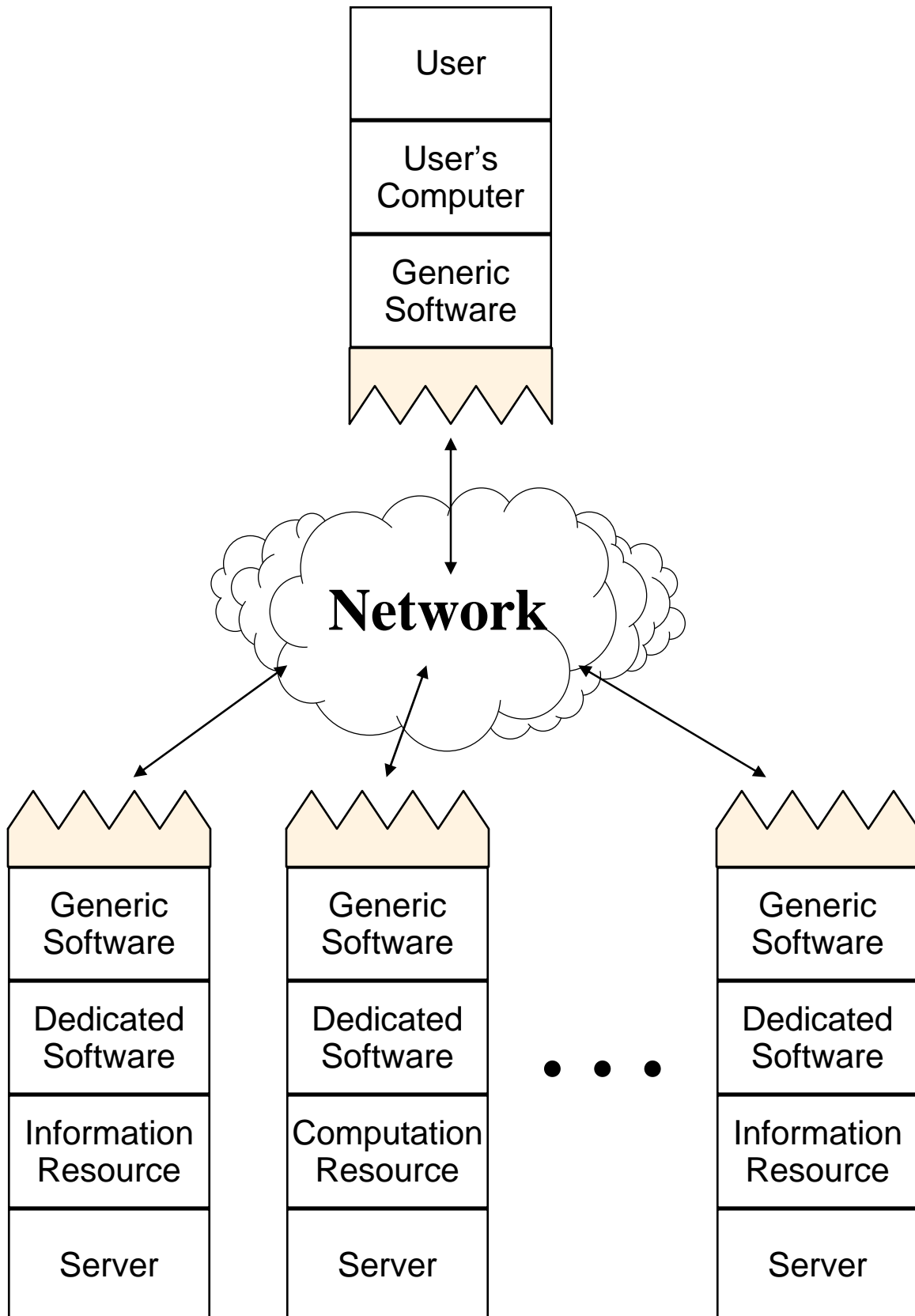

GenQuest Slides